

# Power MIG Series



# GeKaMac<sup>®</sup>



## **Power MIG 255 Pulse Users Manual**

Please Read and Understand This Manual  
Before Operating The Welding Machine

[www.gedikwelding.com](http://www.gedikwelding.com)

Introduction	2
Description	2
Operating features	2
Technical data	3
Usage limits (IEC 60974-1)	3
How to lift up the system	4
Opening the packaging	4
Installation and connections	4
Connection to the electrical supply	4
Loading wire	5
Assembly of drive rollers	5
Control apparatus	5
MIG-MAG / PULSE MIG / DOUBLE PULSE MIG welding with GAS	6
MIG-MAG / PULSE MIG / DOUBLE PULSE MIG welding without GAS	7
Spot welding	8
Interval welding (Stitch)	8
Aluminium welding	8
Electrode welding (MMA)	8
TIG welding with "Lift"	9
Maintenance	10
Optional	10
The pointing out of any difficulties and their elimination	10
Replacing the digital interface PCB	10
Troubleshooting table	11
Meaning of graphic symbols on machine	12
Wiring diagram	12

## Introduction

Thank you for buying our product.

In order to get the best performance out of the plant and ensure the maximum lifespan of its parts, the use and maintenance instructions contained in this manual must be read and strictly complied with, as well as **the safety instructions contained in the relevant folder**. If repairs to the plant are required, we recommend that our clients contact our service centre work-shops, as they have the necessary equipment and personnel that are specifically trained and constantly updated.

All our machines and equipment are constantly developed and so changes may be made in terms of their construction and features.

## Description

### MULTI-FUNCTION INVERTER GENERATOR FOR MIG-MAG, MMA, and TIG WELDING

The **Power MIG 255 Pulse** series of multi-function equipments are characterised by cutting edge, attractive design combined with latest generation inverter technology and digital welding control. Innovative, technologically advanced, robust, and easy to use, they can be used for very high quality MIG-MAG and Pulse MIG welding for all materials and especially stain-less steel and aluminium, reducing repeat work due to spray to a minimum, using electrodes, and in TIG with "Lift" type ignition, and they represent the best solution for all industrial fields and all specialist welding purposes that call for high precision and repeatable results. **Power MIG 255 Pulse** equipments, fitted with the extraordinary VISION-ARC meet the needs of those that wish to combine synergy with complete control of all welding parameters. These are systems open to the future evolution of technology - the control software can be kept up to date with

## Operating features

The main feature of the welding unit **Power MIG 255 Pulse** are:

- Metallic main structure with shockproof plastic front frame.
- Controls protected by a visor.
- Exceptional characteristics for MIG-MAG, MMA, and TIG welding with "Lift" type ignition.
- Synergic digital control (CM / CP) of all welding parameters, with the following functions:
  - Allows less expert operators to regulate all welding parameters in a user-friendly way and extremely easily, choosing the type of program on the basis of the material, wire diameter, and gas used.
  - Innovative "VISION ARC" software for controlling all welding parameters.
  - BURN BACK control. At the end of each weld, in any condition and with any material, the digital control ensures a perfect wire cut, prevents the typical "wire globule" from forming and ensures correct arc restriking.
  - WSC Wire start control. This arc striking control device prevents wire from sticking to the workpiece or torch nozzle and ensures precise and smooth arc striking, particularly when welding aluminium.
  - Welding parameters that are controlled digitally by a micro-processor, are monitored and modified in just a few seconds, maintaining a consistently precise and stable arc as the welding conditions continue to vary due to the movement of the torch and the irregularities of the parts to be welded.
  - Exclusive SWS "Smart Welding Stop" system at the end of TIG welding. Lifting up the torch without switching off the

arc will introduce a slope down and it will switch off automatically.

- "Energy Saving" function to operate the power source cooling fan and the torch water cooling only when necessary.
- High electrical performance resulting in a reduction in energy consumption.
- Professional large diameter 4-roller wire feeder that guarantees precise and constant feeding of the wire. This wire feeder's principal characteristics are:
  - Designed for use with all types of solid and core type wire.
  - A 24 V direct current ratio motor.
  - A gas solenoid valve.
  - Wire speed (welding current) and welding voltage adjustment.
  - Graduated knobs for precise adjustment of the wire pressure that stays unvaried when the arms open and close.
  - The feeder rollers can be replaced without using any tools.



## Technical data

The general technical data of the system are summarized in table 1.

## Usage limits (IEC 60974-1)

The use of a welder is typically discontinuous, in that it is made up of effective work periods (welding) and rest periods (for the positioning of parts, the replacement of wire and underflushing operations etc. This welder is dimensioned to supply a  $I_2$  max nominal current in complete safety for a period of work of 35% of the total usage time. The regulations in force establish the total usage time to be 10 minutes. The work cycle is considered to be 35% of this period of time. Exceeding the work cycle allowed could cause a trip switch to trip (for further information see the CM / CP control panel manual), which protects the components inside the welding machine against dangerous overheating. After several minutes the overheat cut-off rearms automatically and the welder is ready for use again.

Table 1

Model	Power MIG 255 Pulse			
	MIG/MAG	TIG	MMA	
Single-phase input 50/60 Hz	V	400 ± 15%		
Mains supply: $Z_{max}$	Ω	0,051		
Power input ( $I_2$ Max)	kVA	10	8,5	11
Delayed fuse ( $I_{eff}$ )	A	16	10	16
Power factor / $\cos\phi$		0,74 / 0,99	0,69 / 0,99	0,77 / 0,99
Efficiency degree	η	0,89	0,86	0,9
Voltage without load	V	60		
Current range	A	10 ÷ 250		
Duty cycle @ 100% (40°C)	A	180		
Duty cycle @ 60% (40°C)	A	200		
Duty cycle @ 35% (40°C)	A	250		
Wires diameter	mm	0,6 - 1,2	-	-
Spool Diameter / Weight	mm / kg	300 / 15	-	-
N° rollers		4	-	-
Power output of feeder motor	W	55	-	-
Rated wire feeding speed	m/min	1,5 ÷ 22	-	-
MMA electrodes	mm	-	-	1,6 - 4,0
TIG electrodes	mm	-	1,0 - 3,2	-
Protection gas		<ul style="list-style-type: none"> <li>• Carbon dioxide</li> <li>• Pure Argon</li> <li>• Argon - Carbon dioxide</li> <li>- Oxygen</li> <li>• Argon and Carbon dioxide blends</li> </ul>	-	-
Standards		IEC 60974-1 - IEC 60974-5 - IEC 60974-10 - 		
Protection class		IP 23 S		
Insulation class		H		
Dimensions 	mm	650 - 388 - 300		
Weight	kg	21		

**WARNING:** This equipment complies with EN/IEC 61000-3-12 provided that the maximum permissible system impedance  $Z_{max}$  is less than or equal to 0,051 Ω at the interface point between the user's supply and the public system. It is the responsibility of the installer or user of the equipment to ensure, by consultation with the distribution network operator if necessary, that the equipment is connected only to a supply with maximum permissible system impedance  $Z_{max}$  less than or equal to 0,051 Ω.

This system, tested according to EN/IEC 61000-3-3, meets the requirements of EN/IEC 61000-3-11.

## How to lift up the system

Strap the system safely and securely in the slings working from the bottom, then lift up from the ground.

This welding machine has a robust handle built into the frame for moving the equipment.

**NOTE:** *These hoisting and transportation devices conform to European standards. Do not use other hoisting and transportation systems.*

## Opening the packaging

The system essentially consists of:

- **Power MIG 255 Pulse** weld unit.
- Separately:
  - MIG-MAG welding torch (optional).
  - Wire-feeder/generator interconnection cable (supplied separately).
  - Coolant unit for welding torch (optional).
  - Trolley to carry it around (optional).

Perform the following operations on receiving the apparatus:

- Remove the welding generator and all accessories and components from the packaging.
- Check that the welding apparatus is in good condition; otherwise immediately inform the retailer or distributor.
- Check that all the ventilation grilles are open and that there is nothing to obstruct the correct air flow.

## Installation and connections

The installation site for the system must be carefully chosen in order to ensure its satisfactory and safe use. The user is responsible for the installation and use of the system in accordance with the producer's instructions contained in this manual. Before installing the system the user must take into consideration the potential electromagnetic problems in the work area. In particular, we suggest that you should avoid installing the system close to:

- Signalling, control and telephone cables.
- Radio and television transmitters and receivers.
- Computers and control and measurement instruments.
- Security and protection instruments.

Persons fitted with pace-makers, hearing aids and similar equipment must consult their doctor before going near a machine in operation. The equipment's installation environment must comply to the protection level of the frame.

The welding unit is characterized by the following classes:

- IP 23 S protection class indicates that the generator can be used in both interior and exterior environments.
  - The "S" usage class indicates that the generator can be employed in environments with a high risk of electrical shocks.
- This system is cooled by means of the forced circulation of air, and must therefore be placed in such a way that the air may be easily sucked in and expelled through the apertures made in the frame.

Assemble the system in the following way:

- Assemble the trolley.
- Fixing the cooling unit to the trolley.
- Fixing of the welding machine to the trolley and the cooling unit (electrical and plumbing connections).
- Connect up the welder to the mains.
- Connect up the wire-feeder/generator interconnection cable.
- Connect up the welding cables.

Instructions for fitting the individual components / optional extras are contained in the relevant packaging.

## Connection to the electrical supply

**Connection of the machine to the user line (electrical current) must be performed by qualified personnel.**

**Before connecting the welding machine to the mains power supply, make sure that rated voltage and frequency correspond to those provided by the mains power supply and that the welding machine's power switch is turned to "O".**

Use the welder's own plug to connect it up to the main power supply. Proceed as follows if you have to replace the plug:

- 3 conducting wires are needed for connecting the machine to the supply.
- The fourth, which is YELLOW GREEN in colour is used for making the "GROUND" connection.

**Before connecting the welding machine to the mains power supply, make sure that rated voltage and frequency correspond to those provided by the mains power supply and that the welding machine's power switch is turned to "O".**

Table 2 shows the capacity values that are recommended for fuses in the line with delays.

**NOTE:** *Any extensions to the power cable must be of a suitable diameter, and absolutely not of a smaller diameter than the special cable supplied with the machine.*

**Table 2**

Model		Power MIG 255 Pulse		
		MIG/MAG	TIG	MMA
Power input (I <sub>2</sub> Max)	kVA	10	8,5	11
Delayed fuse (I <sub>eff</sub> )	A	16	10	16
Duty cycle @ 35% (40°C)	A	250		
Mains cable				
Length	m	4		
Section	mm <sup>2</sup>	2,5		
Ground cable				
Length	m	3 - 4		
Section	mm <sup>2</sup>	35		

## Loading wire

- Fit the reel (diam. 300 mm) on the support so that the wire unrolls clockwise, and center the projecting reference on the support with the relative hold on the reel.
- Thread the end of the wire into the back guide (Pos. 1, Fig. A) on the drawing mechanism.
- Lift up the idle rolls (Pos. 4, Fig. A) releasing the roll pressure device (Pos. 2, Fig. A). Make sure that the drive rolls (Pos. 7, Fig. A) have the diameter corresponding to the wire being used stamped on the outside.
- Insert the wire into the central wire guide and the wire guide on the centralised connection (Pos. 5, Fig. A) by a few centimetres. Lower the idle roller holder arms, making sure that the wire slots into the hollow in the motor's roller. If necessary, adjust the pressure between the rollers by turning the relevant screw (Pos. 2, Fig. A). The correct pressure is the minimum that does not allow the rollers to skid on the wire. Excessive pressure will cause deformation of the wire and tangling on the entrance of the sheath; insufficient pressure can cause irregular welding.

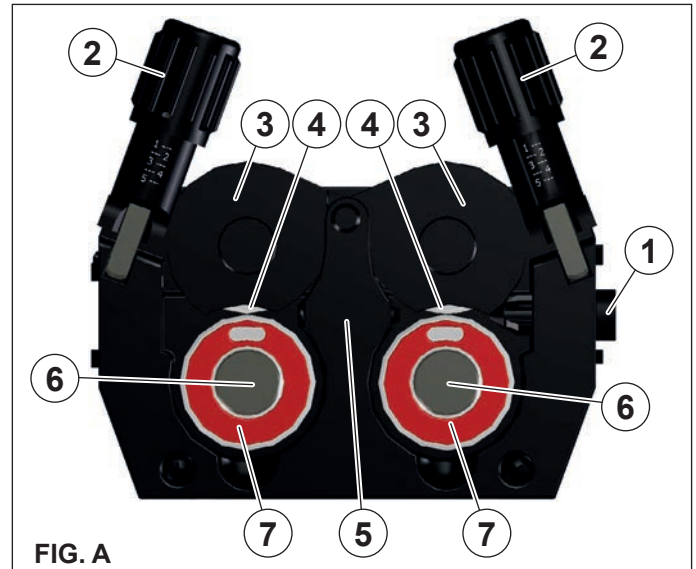

## Assembly of drive rollers

Unscrew the two screws (Pos. 6, Fig. A). Lift up the idle roll-holder arm (Pos. 3, Fig. A) and proceed as follows:

- Each roller shows the type of wire and diameter on the two external sides.
- Install the right rolls (Pos. 7, Fig. A) making sure the groove is in the correct position for the diameter of the wire being used.

## Control apparatus

### ► Fig. B

- Pos. 1** CM / CP control panel.
- Pos. 2** Up/Down connector.
- Pos. 3** Centralized torch connection.
- Pos. 4** Rapid coupling neutral position, used only for MMA and TIG electrode welding.
- Pos. 5** Fast coupling positive polarity.
- Pos. 6** Cable to change polarity.
- Pos. 7** Fast coupling negative polarity.
- Pos. 8** Power supply switch. In the "O" position the welder is off.
- Pos. 9** Mains cable.
- Pos. 10** Gas hose.
- Pos. 11** Connector for connecting the cooling system.



## MIG-MAG / PULSE MIG / DOUBLE PULSE MIG welding with GAS

To begin MIG-MAG / PULSE MIG / DOUBLE PULSE MIG welding, carry out the following tasks (with the machine switched off).

### 1 - Connecting the cables (Fig. C1)

- 1) Connect the gas hose to the pressure reducer fitted on the cylinder beforehand. Gas cylinders are supplied with a pressure reducer to adjust pressure of the gas used for welding.
- 2) Screw the torch to the centralised connection on the front panel of the welding machine (Pos. 3, Fig. A).
- 3) Connect up the earthing system cable to the rapid coupling marked by a - (negative) symbol and then the relevant ground clamps to the piece being welded or to its support in an area free from rust, paint and grease. Using particularly long earthing cables reduces the voltage and causes some problems from increased resistance and inductance of the cables that could cause faulty welding. Follow instructions to avoid these problems:
  - Use earthing and extension cables with appropriate section.
  - Lay out the cables as a flat as possible to prevent them from coiling up.
- 4) Connect the reverse polarity cable to the positive terminal (Fig. C2).

### 2 - Welding

- 1) Switch the welding machine on by moving the power supply switch to I (Pos. 6, Fig. B).
- 2) Make the adjustments and do the parameter settings on the CM / CP control panel (for further information see the CM / CP control panel manual).
- 3) Load the wire using the torch button, after having removed the wire guide nozzle from the torch to allow the wire to come out freely, while loading (remember that the wire guide nozzle must correspond to the diameter of the wire used).
- 4) Open the tap on the cylinder slowly and adjust the reducer knob to obtain a pressure of about 1,3 to 1,7 bar, and regulate the flow to a value between 14 and 20 lit/min to suit the current used for welding.
- 5) The welding machine is ready to weld. Start welding by moving close to the welding point and press the torch button.
- 6) Once welding has been completed remove any slag, switch off the machine (which is only to be done when the fan is not running), and close the gas cylinder.

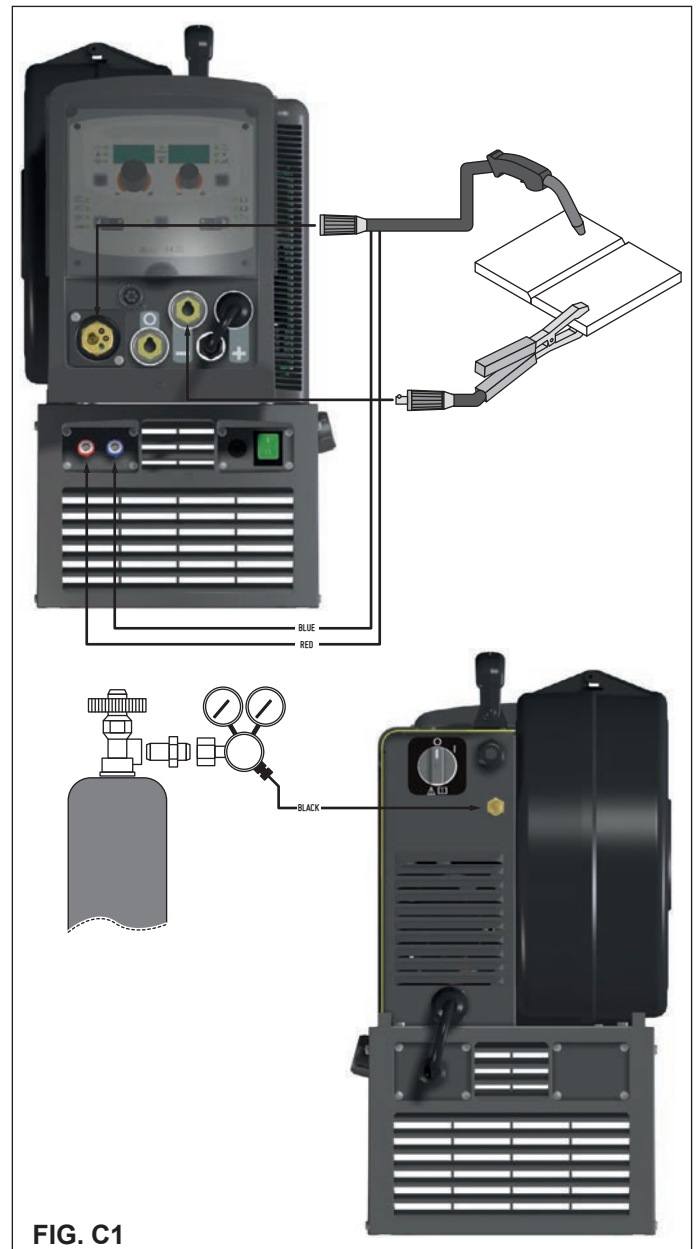

FIG. C1



FIG. C2

## MIG-MAG / PULSE MIG / DOUBLE PULSE MIG welding without GAS

To begin MIG-MAG / PULSE MIG / DOUBLE PULSE MIG welding, carry out the following tasks (with the machine switched off).

### 1 - Connecting the cables (Fig. D1)

- 1) Screw the torch to the centralised connection on the front panel of the welding machine (Pos. 3, Fig. A).
- 2) Connect up the earthing system cable to the rapid coupling marked by a + (positive) symbol and then the relevant ground clamps to the piece being welded or to its support in an area free from rust, paint and grease. Using particularly long earthing cables reduces the voltage and causes some problems from increased resistance and inductance of the cables that could cause faulty welding. Follow instructions to avoid these problems:
  - Use earthing and extension cables with appropriate section.
  - Lay out the cables as a flat as possible to prevent them from coiling up.
- 3) Connect the reverse polarity cable to the negative terminal (Fig. D2).

### 2 - Welding

- 1) Switch the welding machine on by moving the power supply switch to I (Pos. 6, Fig. B).
- 2) Make the adjustments and do the parameter settings on the CM / CP control panel (for further information see the CM / CP control panel manual).
- 3) Load the wire using the torch button, after having removed the wire guide nozzle from the torch to allow the wire to come out freely, while loading (remember that the wire guide nozzle must correspond to the diameter of the wire used).
- 4) The welding machine is ready to weld. Start welding by moving close to the welding point and press the torch button.
- 5) Once welding has been completed remove any slag, switch off the machine.

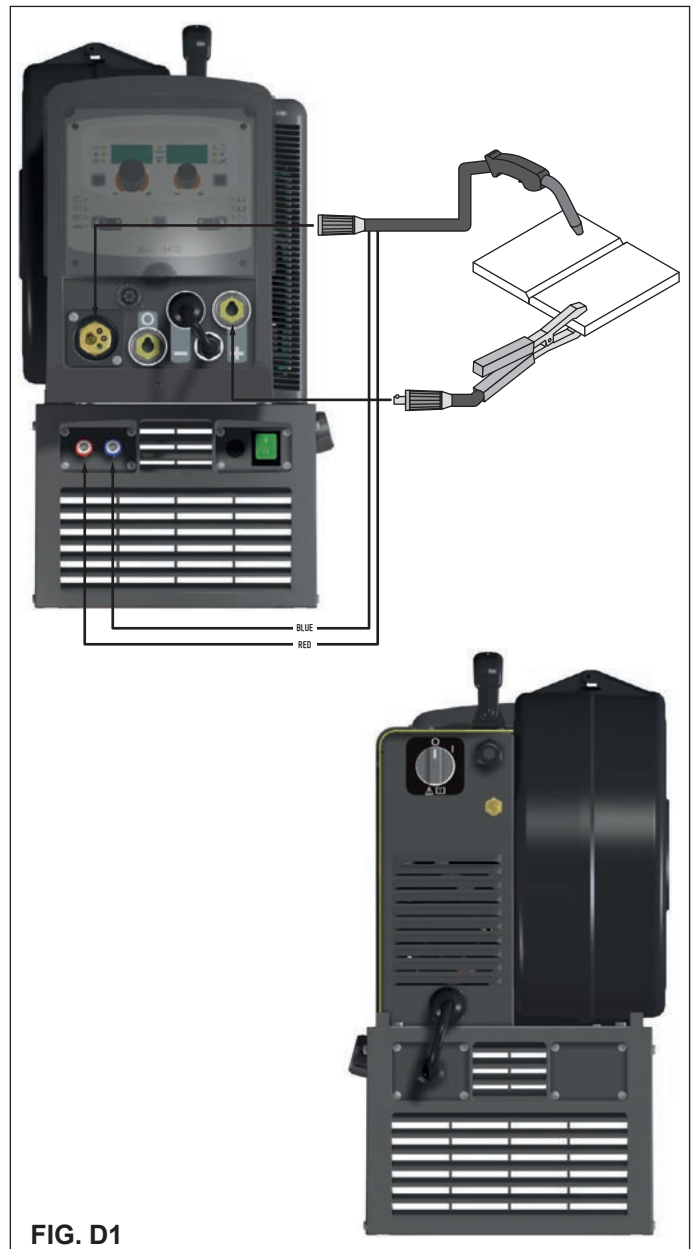

FIG. D1



FIG. D2

## Spot welding

Welding can be done with or without gas. The substantial difference with MIG-MAG welding is essentially related to the torch and the adjustments that must be made on the CM / CP control panel.

- Depending on the torch chosen and the work to be done, a gas guide nozzle can be fitted on the torch that is specifically for spot welding (see Fig. E).
- Use the control panel to select the spot-welding mode and, if necessary, make the changes to the related "Special functions - Fx" (for further information see the CM / CP control panel manual), which allows the machine to do this specific type of welding.

To begin spot welding:

- Place the gas guiding nozzle perpendicular on the workpiece to be spot welded.
- Press the torch button to start the welding current and wire feed.
- When the spot welding time expires (SPOT WELD TIME), the wire feed stops automatically.
- When the torch button is pushed again a new welding cycle starts.
- Release the torch button.

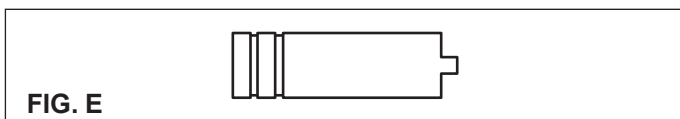

FIG. E

## Interval welding (Stitch)

The substantial differences with the spot welding mainly concern the adjustments that must be carried on the welding machine.

Use the control panel to select the interval welding mode and then make the changes to the related "Special functions - Fx" (for further information see the CM / CP control panel manual), which allows the machine to do this specific type of welding.

To begin interval welding:

- Press the torch button to start the welding current and wire feed.
- At this point the welding machine automatically carries out a succession of welded portions (STITCH WELD TIME) followed by a pause (STITCH WELD PAUSE), according to the times entered previously. This procedure stops automatically only when the TORCH BUTTON is released.
- When the torch button is pushed again the torch begins a new interval welding cycle.

## Aluminium welding

To weld with aluminium wire proceed as follows:

- Replace the drive rolls with special ones for aluminium wire.
- Use a torch with a 3M cable and a carbon Teflon sheath.
- Set the pressure between the drive rollers at the minimum, by turning the screw provided.
- Use argon gas at a pressure of 1,3 - 1,7 bar and regulate the flow to a value between 14 and 20 lit/min to suit the current used for welding.

## Electrode welding (MMA)

On the **Power MIG 255 Pulse** machine, electrode welding is used to weld most metals (different types of steel, etc.) using coated rutilic and basic electrodes with diameters ranging from  $\varnothing$  1.6 mm to  $\varnothing$  6 mm, and devices that the user can adjust for "Arc Force", "Hot Start", and Anti-sticking functions to avoid the electrodes sticking.

- 1) Connecting the welding cables (Fig. F):  
Disconnect the machine from the mains power supply and connect the welding cables to the output terminals (Positive and Negative) of the welding machine, attaching them to the clamp and ground with the polarity specified for the type of electrode being used (Fig.F). Always follow the electrode manufacturer's instructions. The welding cables must be as short as possible, they must be near to one another, positioned at or near floor level. Do not touch the electrode clamp and the ground clamp simultaneously.
- 2) Switch the welding machine on by moving the power supply switch to I (Pos. 8, Fig. B).
- 3) Make the adjustments and do the parameter settings on the CM / CP control panel (for further information see the CM / CP control panel manual).
- 4) Carry out welding by moving the torch to the workpiece. Strike the arc (press the electrode quickly against the metal and then lift it) to melt the electrode, the coating of which forms a protective residue. Then continue welding at an inclination of about  $60^\circ$  compared with the metal in relation to the direction of welding.

### PART TO BE WELDED

The part to be welded must always be connected to ground in order to reduce electromagnetic emission. Much attention must be afforded so that the ground connection of the part to be welded does not increase the risk of accident to the user or the risk of damage to other electric equipment. When it is necessary to connect the part to be welded to ground, you should make a direct connection between the part and the ground shaft. In those countries in which such a connection is not allowed, connect the part to be welded to ground using suitable capacitors, in compliance with the national regulations.



FIG. F



## WELDING PARAMETERS

Table 3 shows some general indications for the choice of electrode, based on the thickness of the parts to be welded. The values of current to use are shown in the table with the respective electrodes for the welding of common steels and low-grade alloys. These data have no absolute value and are indicative data only. For a precise choice follow the instructions provided by the electrode manufacturer.

The current to be used depends on the welding positions and the type of joint, and it increases according to the thickness and dimensions of the part.

The current intensity to be used for the different types of welding, within the field of regulation shown in table 4 is:

- High for plane, frontal plane and vertical upwards welding.
- Medium for overhead welding.
- Low for vertical downwards welding and for joining small pre-heated pieces.

A fairly approximate indication of the average current to use in the welding of electrodes for ordinary steel is given by the following formula:

$$I = 50 \times (\varnothing e - 1)$$

Where:

I = intensity of the welding current

$\varnothing e$  = electrode diameter

Example:

For electrode diameter 4 mm

$$I = 50 \times (4 - 1) = 50 \times 3 = 150A$$

## TIG welding with "Lift"

In the TIG process welding is achieved by melting the two metal pieces to be joined, with the possible addition of material from the outside, using an arc ignited by a tungsten electrode. The "Lift" type ignition used in **Power MIG 255 Pulse** equipments makes it possible to reduce tungsten inclusions on ignition to a minimum. The molten bath and the electrode are protected by and inert gas (for example, Argon). This type of welding is used to weld thin sheet metal or when elevated quality is required.

- 1) Connecting the welding cables (Fig. G):
  - Connect one end of the gas hose to the gas connector on the TIG torch and the other end to the pressure reducer on the inert gas cylinder (Argon or similar).

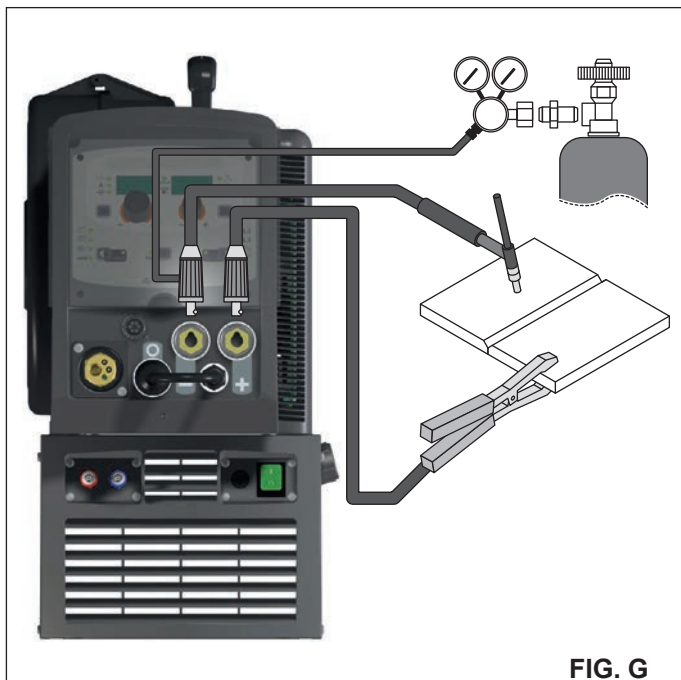

FIG. G

Table 3

Welding thickness (mm)	$\varnothing$ electrode (mm)
1,2 ÷ 2	1,6
1,5 ÷ 3	2
3 ÷ 5	2,5
5 ÷ 12	3,25
≥ 12	4
≥ 20	≥ 5

Table 4

$\varnothing$ electrode (mm)	Current (A)
1,6	30 ÷ 60
2	40 ÷ 75
2,5	60 ÷ 110
3,2	95 ÷ 140
4	140 ÷ 190
5	190 ÷ 240
6	220 ÷ 330

- With the machine switched off:
    - Connect the ground cable to the snap-on connector marked + (positive).
    - Connect the relative ground clamp to the workpiece or to the workpiece support in an area free of rust, paint, grease, etc..
    - Connect the TIG torch power cable to the snap-on connector marked - (negative).
- 2) Switch the welding machine on by moving the power supply switch to I (Pos. 8, Fig. B).
  - 3) Make the adjustments and do the parameter settings on the CM / CP control panel (for further information see the CM / CP control panel manual).
  - 4) Open the gas cylinder and regulate the flow by adjusting the valve on the TIG torch by hand.
  - 5) Ignite the electric arc by contact, using a decisive, quick movement without dragging the tungsten electrode on the piece to be welded ("Lift" type ignition).
  - 6) The welder has a SWS "Smart Welding Stop" system for the end of TIG welding. Lifting up the torch without switching off the arc will introduce a slope down and it will switch off automatically.
  - 7) When you have finished welding remember to shut the valve on the gas cylinder.

Table 5 shows the currents to use with the respective electrodes for TIG DC welding. This input is not absolute but is for your guidance only; read the electrode manufacturers' instructions for a specific choice. The diameter of the electrode to use is directly proportional to the current being used for welding.

Table 5

$\varnothing$ ELECTRODE (mm)	ELECTRODE TYPE Current adjustment field (A)	
	TIG DC	
	Tungsten Ce 1% Grey	Tungsten Rare ground 2% Turquoise
1	10-50	10-50
1,6	50-80	50-80
2,4	80-150	80-150
3,2	150-250	150-250
4	200-400	200-400

## Maintenance

---

**ATTENTION:** *Cut off the power supply to the equipment before effecting any internal inspection.*

### Power MIG 255 Pulse

**IMPORTANT:** *For fully electronic welding machines, removing the dust by sucking it into the machine by the fans, is of utmost importance.*

In order to achieve correct functioning of the machine, proceed as described:

- Periodic removal of accumulations of dirt and dust inside the equipment using compressed air. Do not point the jet of air directly at the electrical parts as this could damage them.
- Periodical inspection for worn cables or loose connections that could cause overheating.

### TORCH

The torch is subjected to high temperatures and is also stressed by traction and torsion. We recommend not to twist the wire and not to use the torch to pull the welder. As a result of the above the torch will require frequent maintenance such as:

- Cleaning welding splashes from the gas diffuser so that the gas flows freely.
- Substitution of the contact point when the hole is deformed.
- Cleaning of the wire guide liner using trichloroethylene or specific solvents.
- Check of the insulation and connections of the power cable; the connections must be in good electrical and mechanical condition.

### SPARE PARTS

Original spares have been specifically designed for our equipment. The use of spares that are not original may cause variations in the performance and reduce the safety level of the equipment. We are not liable for damage due to use of spare parts that are not original.

## Optional

---

### AIR AND/OR WATER COOLED UP/DOWN TORCH

This command and works as an alternative:

- To the ENCODER - SX knob on the welding machine's DH control panel. In "synergic" MIG MAG and "manual" MIG MAG welding processes, by pressing the two right (+) and left (-) buttons you can regulate the values for the synergic welding parameters.
- To the ENCODER - DX knob on the welding machine's DH control panel. In the JOB welding process, by pressing the two right (+) and left (-) buttons you can scroll the welding points set previously.

## The pointing out of any difficulties and their elimination

---

The supply line is attributed with the cause of the most common difficulties. In the case of breakdown, proceed as follows:

- 1) Check the value of the supply voltage.
- 2) Check that the power cable is perfectly connected to the plug and the supply switch.
- 3) Check that the power fuses are not burned out or loose.
- 4) Check whether the following are defective:
  - The switch that supplies the machine
  - The plug socket in the wall
  - The generator switch

**NOTE:** *Given the required technical skills necessary for the repair of the generator, in case of breakdown we advise you to contact skilled personnel or our technical service department.*

## Replacing the digital interface PCB

---

Proceed as follows:

- Unscrew the 4 screws fastening the front rack panel.
- Remove both the adjustment knobs.
- Extract wiring connectors from the digital interface PCB.
- Unscrew the nuts and washers on the support.
- Remove the digital interface PCB by lifting it out of its supports.
- Proceed vice versa to assemble the new digital interface PCB.







## Troubleshooting table





**WARNING:** Any internal inspections or repairs are only to be done by qualified personnel!

**IMPORTANT:** Remember to disconnect the mains power supply and wait for the internal capacitors to discharge (about 2 minutes) before starting to check and repair the machine if necessary.

Defect	Solution
The welding machine does not switch on, CM / CP control panel switched off.	<ul style="list-style-type: none"><li>• Check that the welding machine is installed correctly and that the mains supply has sufficient power to supply the welding machine.</li><li>• Check the switch, cable and plug on the power supply line and replace them if necessary.</li><li>• Check, and if necessary replace, the digital interface PCB or the control PCB.</li></ul>
Line fuses fused "instantaneously".	<ul style="list-style-type: none"><li>• Check that the welding machine is installed correctly.</li><li>• Check and if necessary replace the motor, transformer, or rectifier.</li></ul>
Line fuses fused after a work period.	<ul style="list-style-type: none"><li>• Check that you have fitted line fuses of adequate absorption capacity.</li></ul>
Welding machine on, CM / CP control panel on, fan stopped.	<ul style="list-style-type: none"><li>• Check the wiring that powers the fans.</li><li>• Check that there are no mechanical impediments blocking the fans.</li><li>• Check and if necessary replace the digital interface PCB.</li></ul>
Welding machine on, display does not show correct values.	<ul style="list-style-type: none"><li>• See the error codes and signals shown in the manual for the CM / CP control panel.</li><li>• Check the wiring that powers the various boards.</li><li>• Check, and if necessary replace, the digital interface PCB or the control PCB.</li></ul>
No gas coming out of the torch.	<ul style="list-style-type: none"><li>• Check and if necessary replace the solenoid valve or gas hose.</li><li>• Check the wiring that powers the gas solenoid valve.</li><li>• Check, and if necessary replace, the digital interface PCB or the control PCB.</li></ul>
The wire feed motor does not work during MIG-MAG welding.	<ul style="list-style-type: none"><li>• Check the wiring that powers the wire feed motor.</li><li>• Check that there are no mechanical impediments blocking the motor.</li><li>• Check that the motor is working correctly and if necessary replace it.</li><li>• Check and if necessary replace the digital interface PCB.</li></ul>
Welding current insufficient or not constant.	<ul style="list-style-type: none"><li>• Check the power supply line.</li><li>• Check and if necessary replace the wires (section or length inadequate).</li><li>• Check the line voltage using a voltmeter.</li></ul>
Arc ignition difficult, the arc switches off immediately after ignition during MIG-MAG welding.	<ul style="list-style-type: none"><li>• Use the CM / CP control panel manual to make sure you have set the various welding parameters correctly.</li><li>• Check compatibility of the torch and the wire used.</li><li>• Check that the torch and all its components are working correctly and replace them if necessary (e.g. worn components).</li><li>• Check and if necessary replace the digital interface PCB.</li></ul>
The wire sticks to the workpiece to be welded.	<ul style="list-style-type: none"><li>• Check that there are no mechanical impediments blocking correct unwinding of the wire.</li><li>• Check that the motor is working correctly and if necessary replace it.</li><li>• Check and if necessary replace the digital interface PCB.</li></ul>

## Meaning of graphic symbols on machine

	Power supply switch
	System for use in environments with increased risk of electroshock
	Product suitable for free circulation in the European Community
	Danger! high voltage
	Grounding
	Positive pole snap-in connector

	Negative pole snap-in connector
	Warning!
	Before using the equipment you should carefully read the instructions included in this manual
	Danger! Parts moving
	It is forbidden to use gloves
	Special disposal

## Wiring diagram

### KEY TO THE ELECTRICAL DIAGRAM

•1 BP	•2 BS	•3 C-LINK	•4 CA	•5 CHR	•6 EC	•7 EMCF	•8 EVG	•9 F 1-2-3	•10 IL
•11 L	•12 MT	•13 MV	•14 PT	•15 RF	•16 RP	•17 SC	•18 SDF	•19 SP	•20 SRP
•21 TA	•22 TEL	•23 TIG	•24 TM	•25 TP	•26 TRS				

•1 Primary transformer coil •2 Secondary transformer coil •3 Capacitor •4 Up/Down connector •5 Power supply connector for the cooling system •6 EURO connector •7 EMC filter •8 Gas solenoid valve •9 Toroidal ferrite •10 Power supply switch •11 Secondary inductor •12 Drive motor •13 Fan motor •14 Torch button •15 Rack panel •16 Primary rectifier •17 Control PCB •18 Digital interface PCB •19 Inverter PCB •20 Pump control PCB •21 Hall effect transformer •22 MMA torch •23 TIG torch •24 MIG-MAG torch •25 Main transformer •26 Secondary thermostat

### COLOUR KEY

**AN** Orange-Black  
**Ar** Orange  
**AR** Sky Blue-Red  
**Az** Sky Blue  
**Bc** White  
**Bl** Blue  
**BN** White-Black

**Gg** Grey  
**GI** Yellow  
**GV** Yellow-Green  
**Mr** Brown  
**NA** Black-Sky Blue  
**Nr** Black  
**RN** Red-Black

**Ro** Pink  
**Rs** Red  
**Vd** Green  
**VI** Violet

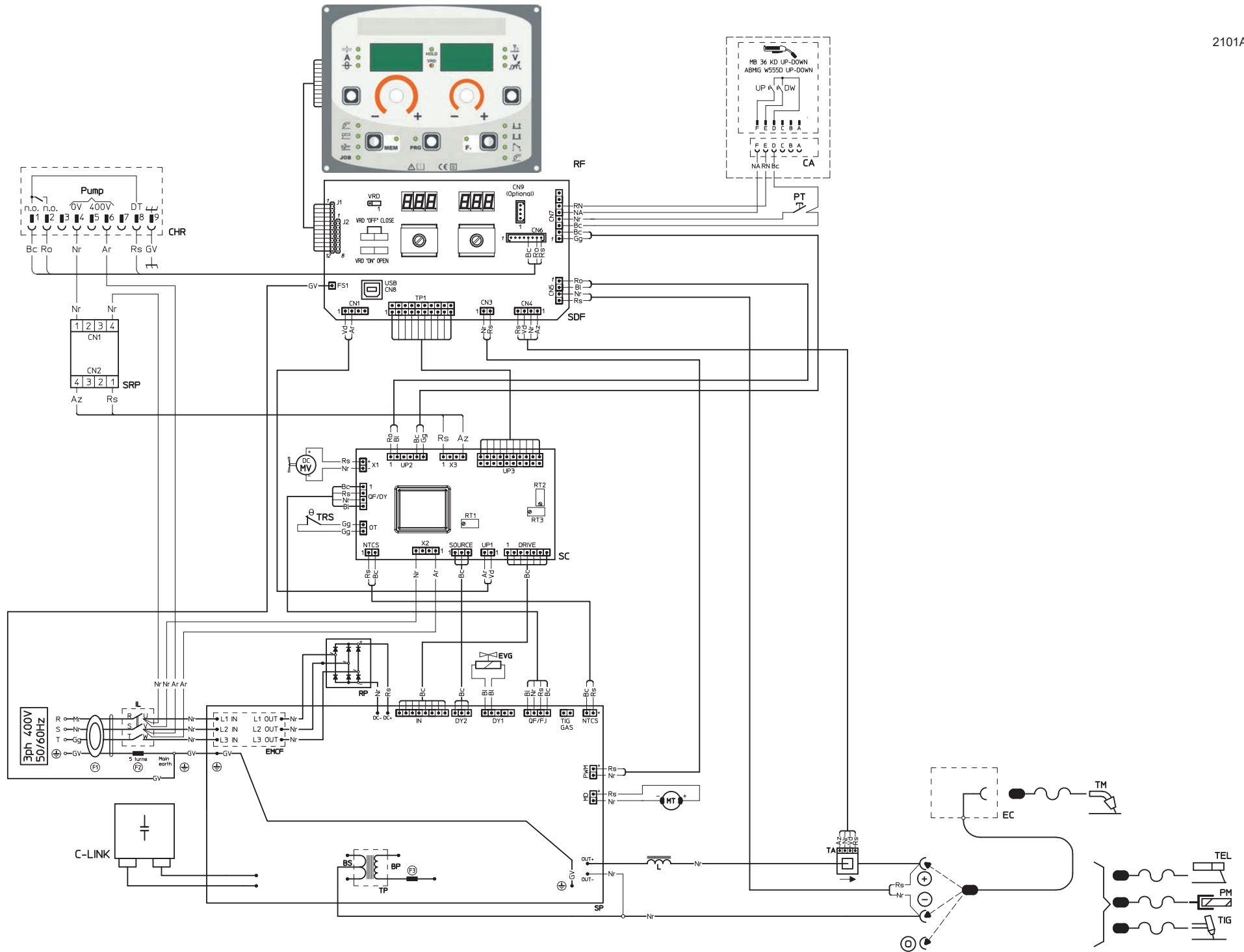

# Power MIG Series



# GeKaMac<sup>®</sup>



## **Power MIG 255 Pulse Spare Parts List**

Please Read and Understand This Manual  
Before Operating The Welding Machine

[www.gedikwelding.com](http://www.gedikwelding.com)



Pos.	Power MIG 255 Pulse	Description
1	352386	Front rack transparent visor
2	258238J	Rack panel with software
3	466895	Adhesive label "MACHINE NAME"
4	438849	Ø22mm Knob without index
5	438888	Ø29mm Knob without index
6	352385	Frame
7	235254	Reverse polarity cable
8	430752	Lock ring
9	403611	Quick connection
10	419050	"UP/DOWN" torch connector
11	236656	Euro connection
12	434247	63,5mm Wire guide tube
13	420666	Left side cover
14	414326	Lock

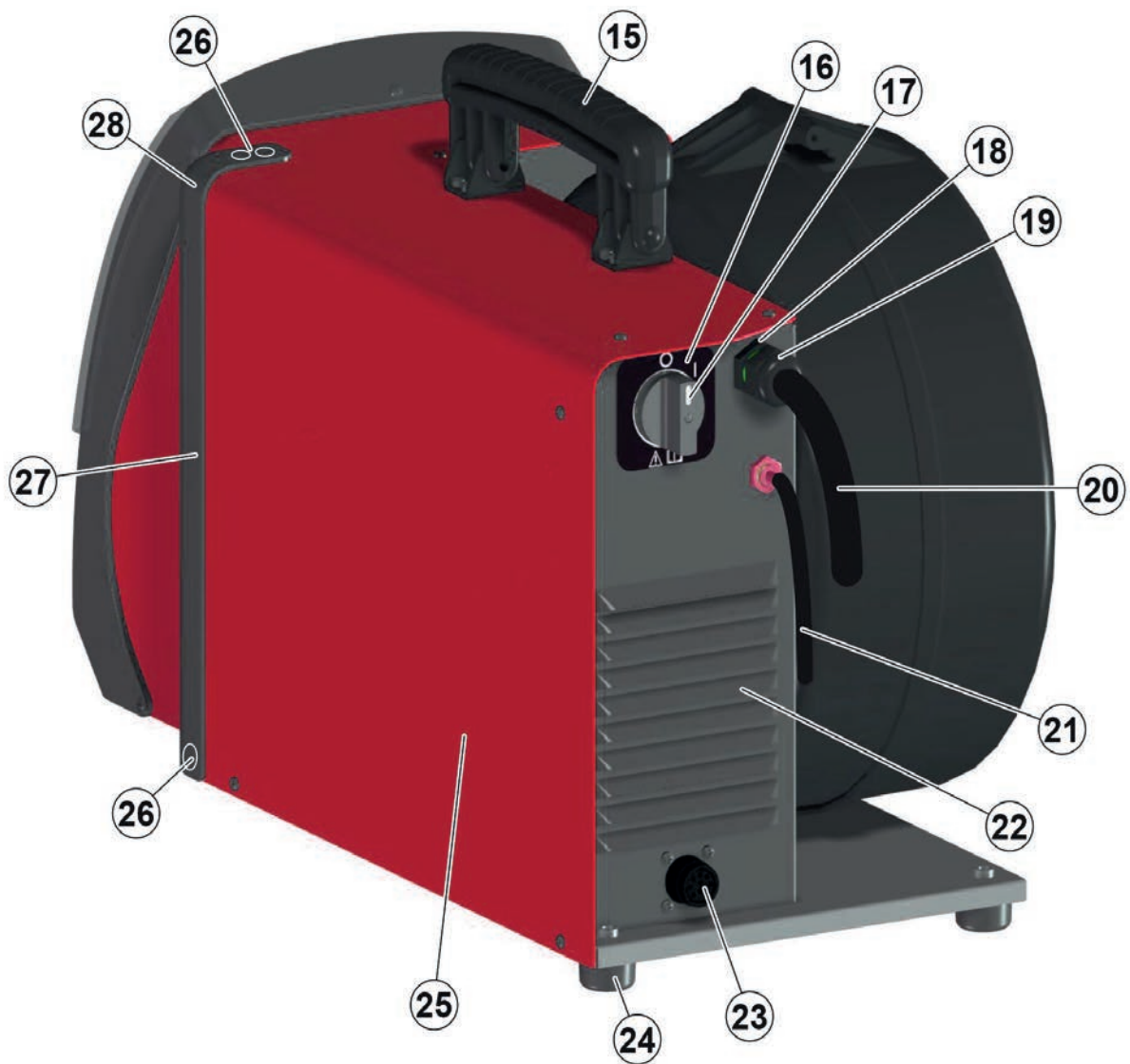

Pos.	Power MIG 255 Pulse	Description
15	438207	Handle
16	468286	Mains switch sticker
17	438720	Mains switch knob
18	427875	Cable clamp
19	430755	Lock ring
20	235948	Mains cable
21	485040	Gas tube
22	404887	Base
23	419049	Cooling system power connector
24	431329	Rubber support foot
25	420604	Cover with stickers
26	352369	Plastic fastening cap
27	352367	Plastic ventilation column
28	352368	Plastic fastening column cover



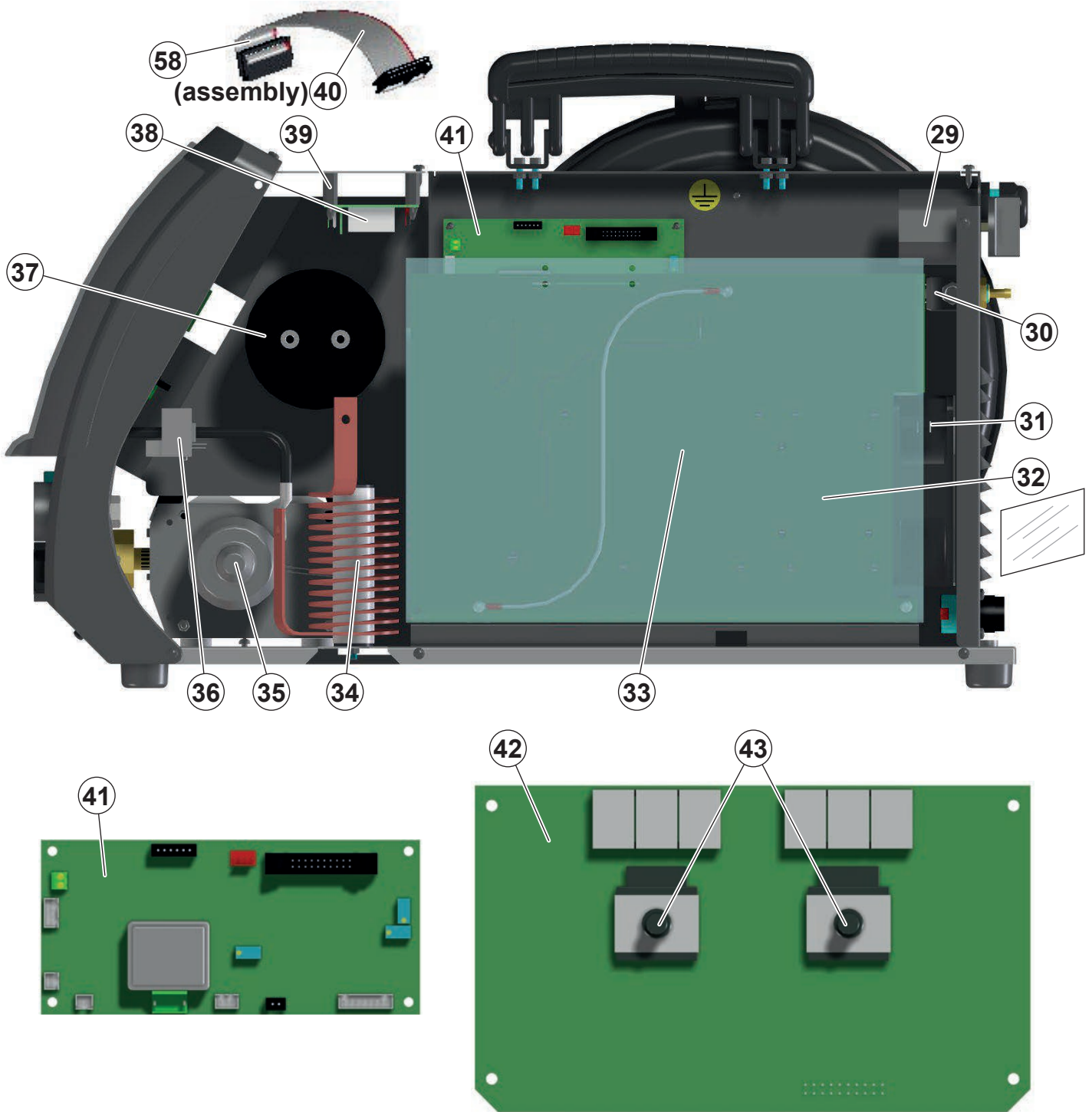

Pos.	Power MIG 255 Pulse	Description
29	435755	Mains switch
30	425938	Solenoide valve
31	444527	Fan motor
32	353449	Cover insulation
33	241269	Power inverter assembly
34	247494	Secondary inductor
35	444474	Horizontal drive motor 24VDC
36	481954	Hall effect transformer
37	418746	DC-LINK capacitor
38	377204	Cooling pump control pcb
39	465247	Pcb insulating support
40	413427	Auxiliary wiring with flat cable assembly
41	377202	Control pcb
42	377179J	Digital Interface PCB
43	454150	Encoder

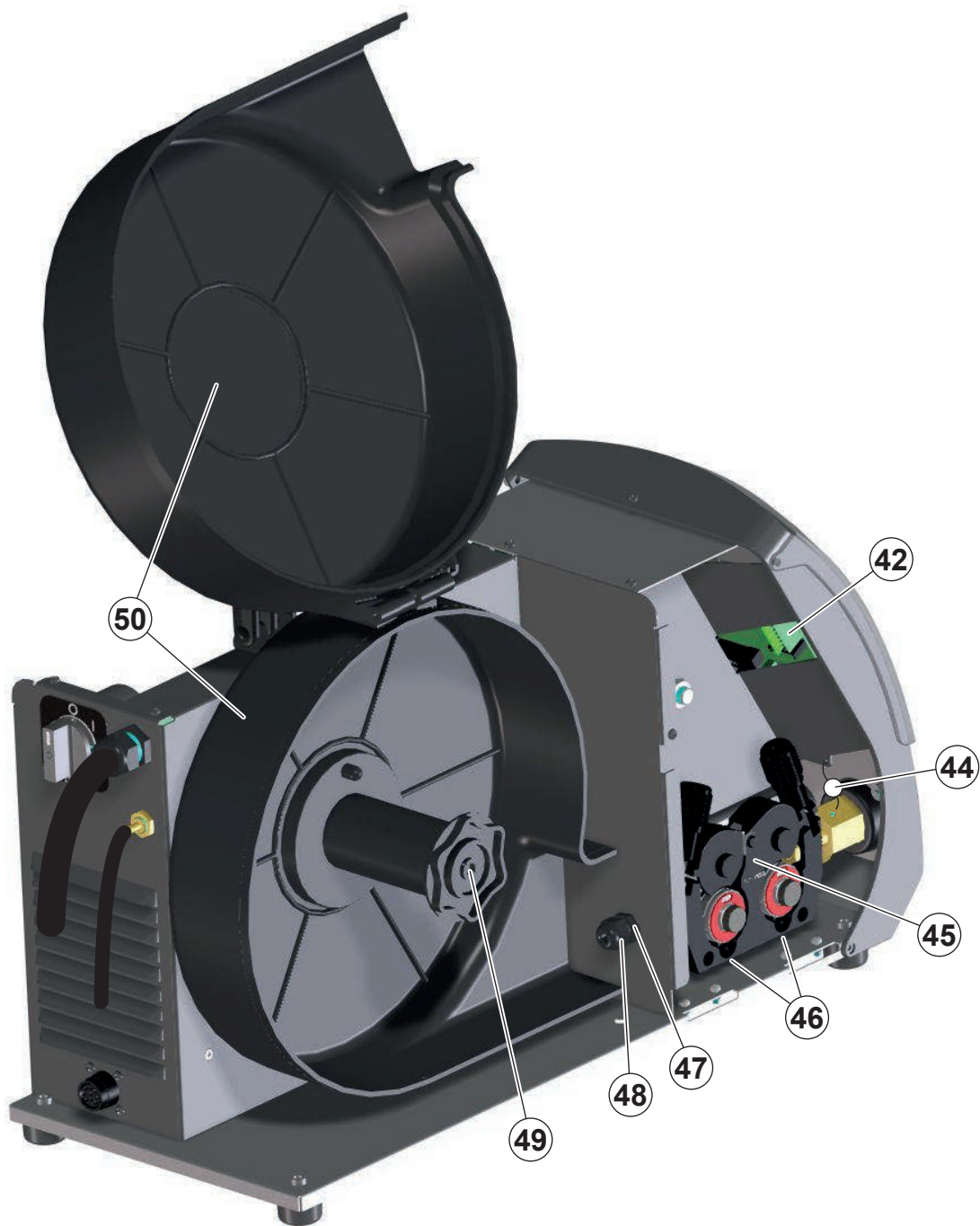

Pos.	Power MIG 255 Pulse	Description
44	488315	Quick connection protection capacitor
45	240618	Wire feed mechanism assembly with drive motor
46	407479	Insulating bushing
47	427865	Spiral cable clamp
48	430750	Lock ring
49	241848	Spool holder
50	420435	Spool cover

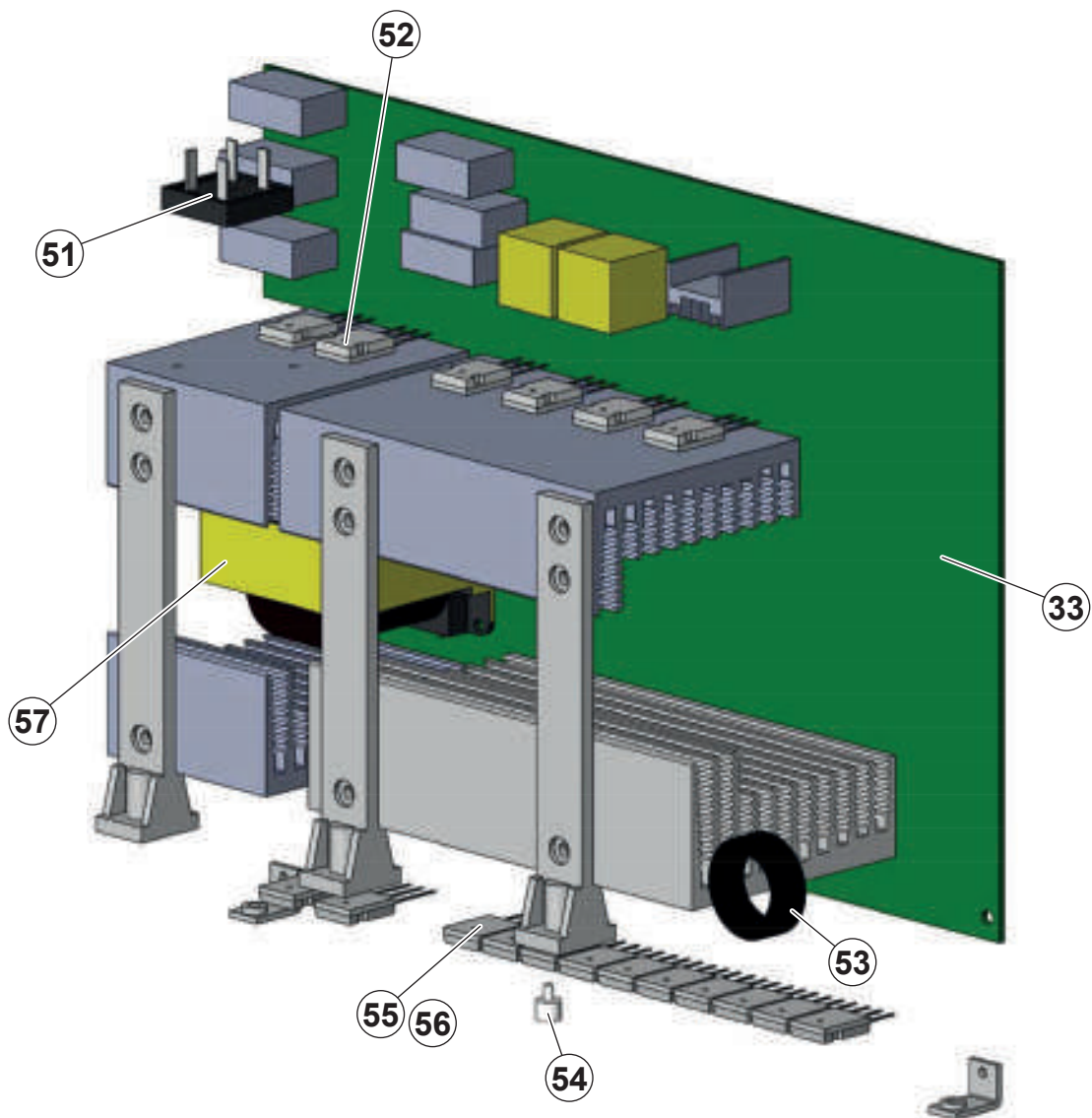

Pos.	Power MIG 255 Pulse	Description
33	241269	Power inverter assembly
51	455514	Three phase rectifier
52	286048	Primary IGBT
53	240249	Inductance
54	478777	Secondary NTC thermostat
*55	423241	Secondary diode 90A 200V
*56	423252	Secondary diode 60A 300V
57	481451	Main transformer
58	413351	Flat cable

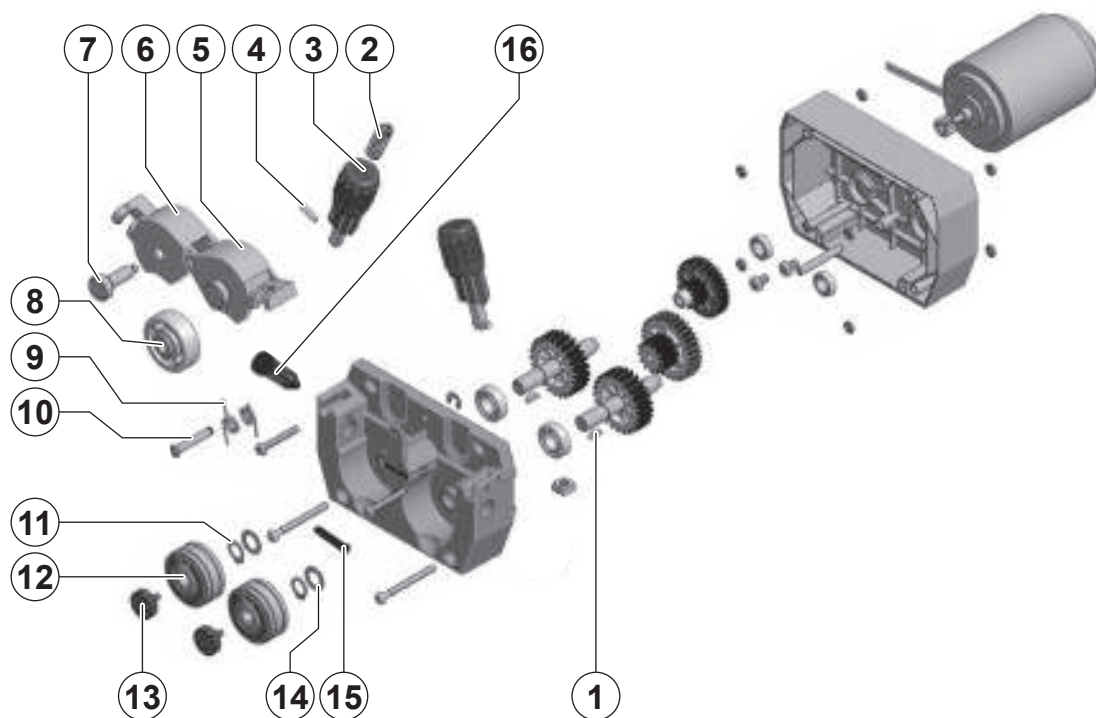

**\* ATTENTION !**  
 The items are not interchangeable:  
 order only the corresponding detail  
 fitted.

**EN** Wire feeder unit assembly with 4 rolls



Pos.	Cod.	Description
1	449041	Woodruff Key
2	441210	Pressure spring Ø 2 mm
3	437075	Pressure Adjustment Unit (2 mm spring)
4	676510	Tapered Pin
5	356971	Pressure Arm right assembly
6	356966	Pressure Arm left assembly
7	449027	Pressure Roll Axle
8	Tab. A	Pressure Roll Ø 37 mm
9	441208	Pressure Arm Spring
10	449034	Pressure Arm Axle
11	600201	Circlip Ø 10 mm
12	Tab. A	Feed Roll Ø 37 mm
13	487803	Roll Fixation Screw
14	424039	Shim Washer
15	434273	Intermediate Wire Guide
16	434274	Inlet Wire Guide

**Table A - SUITABLE ROLLS**

	<b>STANDARD ROLLS FOR HARD WIRE ONLY</b>
	Pressure flat roll for all diameters with bushing
	Feed roll double groove Ø 37 mm with keyway and coloured front ring

EN Wire	EN Wire diameter	EN Upper roller	EN Colored lower roller Ø 37 mm	EN Groove
EN Hard wire	0,6 ÷ 0,8 mm	459001 Ball bearing Ø 37 mm with bushing	459002 green/blue	"V" 35°
	0,8 ÷ 0,9 mm		459005 blue/black	
	0,8 ÷ 1,0 mm		459003 blue/red	
	1,0 ÷ 1,2 mm		459004 red/orange	

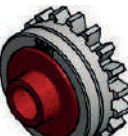
	<b>TWIN ROLLS</b>
	Combined Rolls with color coding mate only with other combined Rolls. Combined Rolls cannot be ordered without color coded bushings.
	Pressure roll single groove Ø 37 mm with ball-bearing and coloured bushing
	Feed roll single groove Ø 37 mm with keyway and coloured bushing

EN Wire	EN Wire diameter	EN Upper roller	EN Colored lower roller Ø 37 mm	EN Groove
EN Aluminium	1,0 mm	459010 red	459013 red	"U"
	1,2 mm	459011 orange	459014 orange	
	1,6 mm	459012 yellow	459015 yellow	
EN Cored wire	1,0 mm	459020 red	459022 red	zigrinata knurled
	1,2 mm	459021 orange	459023 orange	

**EN** Wire feeder maintenance

---

Item	Interval of maintenance	Action
Rolls	Every 500 hours or as needed	Inspect, clean or replace
Wire Guides	Every 500 hours or as needed	Inspect, replace
Roll Fixation Screw	Every 2500 hours or as needed	Inspect, replace

**EN** Ordering spare parts

---

To ask for spare parts clearly state:

- 1) The code number of the piece
- 2) The type of device
- 3) The voltage and frequency read on the rating plate
- 4) The serial number of the same

**EXAMPLE**

N. 2 pieces code n. 488315 - for CONVEX MOBILE 251 - 400  
V - 50/60 Hz - Serial number .....

# Power MIG Series



# GeKaMac<sup>®</sup>



## **Power MIG 255 Pulse Control Panel**

Please Read and Understand This Manual  
Before Operating The Welding Machine

[www.gedikwelding.com](http://www.gedikwelding.com)

<input type="checkbox"/> Introduction	2	<input type="checkbox"/> Special processes	17
<input type="checkbox"/> Control panel	3	<input type="checkbox"/> Electrode (MMA)	17
KEY AND KNOB COMMANDS	3	1 - WELDING PROCESS SELECTION	17
DISPLAY AND LED INDICATIONS	4	2 - SELECTION OF WELDING PROGRAM	17
<input type="checkbox"/> Switching on the welding machine and initial screen	4	3 - SPECIAL FUNCTIONS "Fx" SELECTION	18
<input type="checkbox"/> Viewing the software version installed	4	4 - PRE-SETTING	18
<input type="checkbox"/> Loading of the wire	5	5 - WELDING	18
<input type="checkbox"/> Special functions "Fx"	5	6 - HOLD	19
<input type="checkbox"/> SETUP Menu	7	7 - ACTIVATING THE VRD DEVICE	19
FACTORY DEFAULT (FAC)	7	<input type="checkbox"/> TIG with "Lift" striking	19
TIMER ARC ON	7	1 - WELDING PROCESS SELECTION	19
TIMER WELDING MACHINE ON	7	2 - SPECIAL FUNCTIONS "Fx" SELECTION	19
ERROR LOG	8	3 - PRE-SETTING	20
TEST	8	4 - WELDING	20
<input type="checkbox"/> Menu SPECIAL FUNCTIONS	9	5 - HOLD	20
SAFETY CALIBRATION CODE (SCC)	9	<input type="checkbox"/> JOB	21
MOTOR CALIBRATION (Mot CAL)	9	1 - CREATING AND SAVING A JOB	21
ARC LENGTH ADJUST	10	2 - JOB SELECTION	21
CYCLE	10	3 - PRE-SETTING / VIEWING MEMORISED JOB DATA	21
WATER COOLING MODE	10	4 - WELDING	22
PASSWORD	11	5 - HOLD	22
BLOCKS	11	6 - MODIFICATION AND OVERWRITING OF A MEMORISED JOB	22
SERIAL NUMBER	11	7 - DELETING A JOB SAVED	22
<input type="checkbox"/> MIG-MAG synergic / MIG pulse / double pulsed MIG	12	<input type="checkbox"/> Error condition	23
1 - WELDING PROCESS SELECTION	12		
2 - SELECTION OF WELDING PROGRAMME	12		
3 - WELDING MODE SELECTION	13		
4 - SPECIAL FUNCTIONS "Fx" SELECTION	13		
5 - PRE-SETTING	14		
6 - WELDING	14		
7 - HOLD	14		
<input type="checkbox"/> MIG-MAG manual	15	<input type="checkbox"/> Introduction	
1 - WELDING PROCESS SELECTION	15		
2 - WELDING MODE SELECTION	15		
3 - SPECIAL FUNCTIONS "Fx" SELECTION	15		
4 - PRE-SETTING	16		
5 - WELDING	16		
6 - HOLD	16		

Il presente manuale contiene tutte le informazioni necessarie per This manual contains all the information necessary to make the best use of this control panel. This control panel is specifically for multi-process welding machines: MIG-MAG, PULSED MIG, DOUBLE PULSED MIG, MMA and TIG.



## Control panel

### KEY AND KNOB COMMANDS

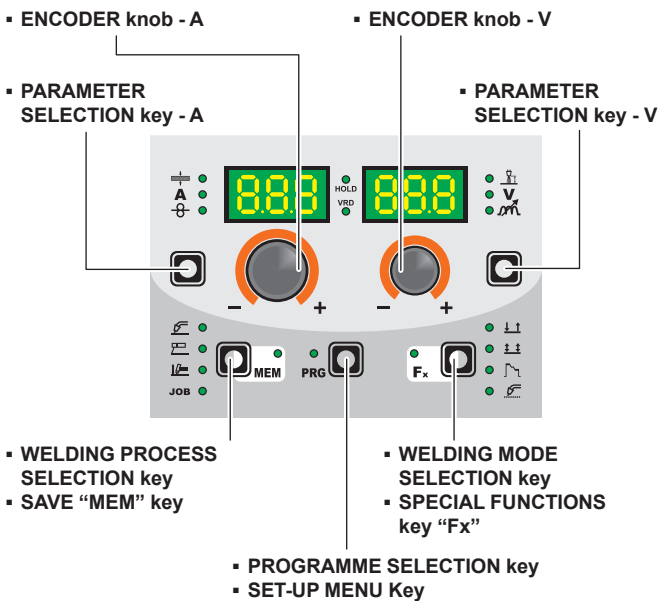

#### ■ PARAMETER SELECTION key - A

This is used to select the following welding parameters:

- THICKNESS OF WELDED ITEM (A).
- WELDING CURRENT (A).
- WIRE SPEED (A).

#### ■ ENCODER knob - A

This is used to set and edit the PARAMETERS - A based on the corresponding LED switched on and the value highlighted on the DISPLAY PARAMETERS - A display, required for correct functioning of the machine.

#### ■ PARAMETER SELECTION key - V

This is used to select the following welding parameters:

- ARC LENGTH ADJUSTMENT (V).
- WELDING VOLTAGE (V).
- ELECTRONIC INDUCTANCE (V).

#### ■ ENCODER knob - V

This is used to set and edit the PARAMETERS - V based on the corresponding LED switched on and the value highlighted on the DISPLAY PARAMETERS - V display, required for correct functioning of the machine.

#### ■ PROGRAMME SELECTION key

It can be used to select the individual welding PROGRAM for MIG-MAG and MMA welding processes.

#### ■ SET-UP MENU Key (T > 3 s)

This provides access to the SET-UP menu, which in turn provides access to a series of functions, suitable for an expert operator.

#### ■ WELDING PROCESS SELECTION key

It can also be used to select the following welding processes:

- MIG-MAG / PULSED MIG / Double PULSED MIG.
- MMA.
- TIG.
- JOB.

#### ■ SAVE "MEM" key (T ≥ 2 s)

It allows the saving of the parameters in the JOB.

It also allows one to view / change the parameters previously saved in the JOB.

**WARNING:** *Flashes while saving a JOB.*

#### ■ WELDING MODE SELECTION key

This is used to select the following welding modes (only for MIG welding processes) and each time the key is pushed the welding machine moves on to select the next welding mode in the following order:

#### TWO STROKE (2T)

2T LED (↓↑) switched on

Pressing the TORCH TRIGGER starts the welding cycle, which will stop when it is released.

#### FOUR STROKE (4T)

4T LED (↓↑) switched on

- 1) Pressing and releasing the TORCH TRIGGER will start the welding cycle.
- 2) Pressing and releasing the TORCH TRIGGER will start the welding cycle.

#### CRATER 2T

2T LED (↓↑) switched on - CRATER LED (Γ) switched on

- 1) When the TORCH TRIGGER is pushed the arc ignites and the parameters assume the values for the "initial crater" for a time set by means of the CRATER START TIME (F10) function. After that the parameter values become those for "welding" for a time defined by the CRATER START SLOPE (F11) function.
- 2) When the TORCH TRIGGER is released the parameters take on the "final crater" values for a time set by means of the CRATER END TIME (F15) function, for a period of time set using the CRATER END SLOPE (F12) function.

#### CRATER 4T

4T LED (↓↑) switched on - CRATER LED (Γ) switched on

- 1) When the TORCH TRIGGER is pushed the arc ignites and the parameters assume the values for the "initial crater".
- 2) When the TORCH TRIGGER is released the parameters take on the "welding" values for a time set using the CRATER START SLOPE (F11) function.
- 3) When the TORCH TRIGGER is pushed again the parameters take on the "final crater" values for a time defined using the CRATER END SLOPE (F12) function.
- 4) Releasing the TORCH TRIGGER will end the welding cycle.

#### SPOT WELDING 2T

2T LED (↓↑) switched on - SPOT LED (S) switched on

This is used so that on pressing the TORCH TRIGGER spot welding is done for a time period set beforehand (in seconds), after which the arc switches off automatically (SPOT WELD TIME F07 function).

#### STITCH WELDING 2T

2T LED (↓↑) switched on - SPOT LED (S) flashing

To begin stitch welding:

- 1) Press the TORCH TRIGGER to start the welding current and wire feed.  
At this point the welder will perform automatically a succession of a welded tracts followed by a pause, respecting the times set in the functions STITCH WELD TIME (F05) and STITCH WELD PAUSE (F06).  
This procedure stops automatically only when the TORCH TRIGGER is released.
- 2) When the TORCH TRIGGER is pushed again the torch begins a new interval welding cycle.

#### CYCLE

4T LED (↓↑) switched on - CRATER LED (Γ) flashing

- 1) When the TORCH BUTTON is pushed, the arc is ignited and the welding parameters take on the values for the *initial crater*.
- 2) When the TORCH BUTTON is released, the current goes to that for *welding* at a time defined by the CRATER START SLOPE function (F11).
- 3) When the TORCH BUTTON is pressed and released within 1 second, the current goes to that defined by the (F19) and (F20) "cycle" functions. By repeating this operation, you can switch an infinite number of times between the *cycle* level and *welding* level.
- 4) When the TORCH BUTTON is pushed again and held down for more than 1 second, after a time defined by the CRATER END SLOPE (F12) function, the welding parameters taken on the values for the *final crater*. When the TORCH BUTTON is released the welding cycle ends.

## ■ SPECIAL FUNCTIONS key “Fx” (T ≥ 2 s)

This key is used to display and edit some parameters (ADJUSTABLE FUNCTIONS “Fx”) that are necessary and fundamental for welding and that have already been set by the manufacturer in the factory.

The parameters vary depending on the welding process and mode used, and are saved in the memory for each automatic welding point (JOB).

**WARNING:** No LED switches on when this key is activated!

## DISPLAY AND LED INDICATIONS

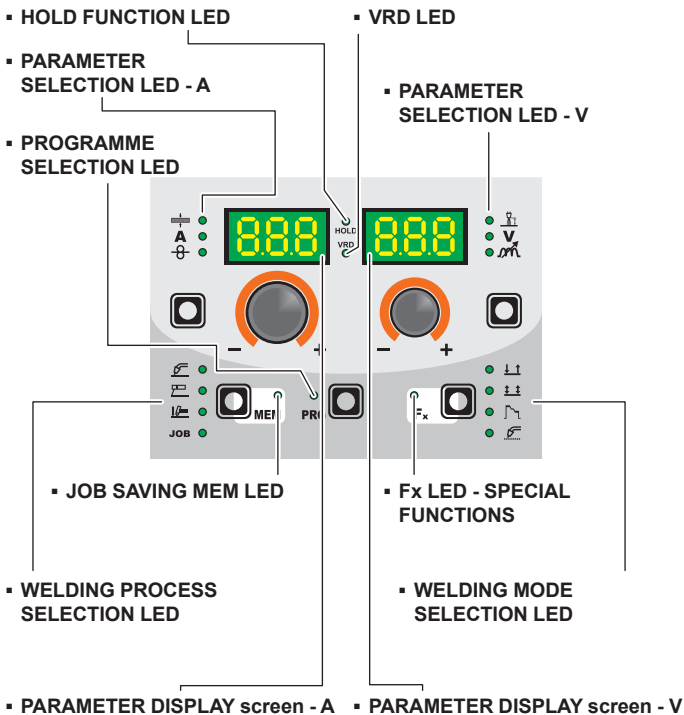

## ■ PARAMETER SELECTION LED - A

When one of these LEDs is on it means that the corresponding welding parameter has been selected.

## ■ PROGRAMME SELECTION LED

This LED will be lit only when the operator selects a welding process (in which there welding programmes present) and the relative associated programme.

## ■ PARAMETER DISPLAY screen - A

This Display shows the values / numbers (set or measured) of the following parameters (if active):

- THICKNESS OF WELDED ITEM (⚡).
- WELDING CURRENT (A).
- WIRE SPEED (⚡).
- WELDING PROGRAM (PRG).

## ■ HOLD FUNCTION LED

Flashing, it indicates that the values of the parameters views on the PARAMETER DISPLAY - A and V are respectively the values that are set or measured at the conclusion of the last welding. The LED flashes for 15 seconds consecutively before turning itself off or until the moment that the operator varies any parameter by means of the use of the handles.

## ■ WELDING PROCESS SELECTION LED

When one of these LEDs is on it means that the corresponding welding process has been selected.

## ■ PARAMETER SELECTION LED - V

When one of these LEDs is on it means that the corresponding welding parameter has been selected.

## ■ PARAMETER DISPLAY screen - V

This Display shows the values / numbers (set or measured) of the following parameters (if active):

- ARC LENGTH ADJUSTMENT (⚡).
- WELDING VOLTAGE (V).
- ELECTRONIC INDUCTANCE (mA).

## ■ JOB SAVING MEM LED

Flashes while saving a JOB.

## ■ Fx LED - SPECIAL FUNCTIONS

Switched on when special Fx parameters are displayed.

## ■ VRD LED

The Voltage Reduction Device (VRD) is a safety device that reduces voltage. It prevents voltages forming on the output terminals that may pose a danger to people.

Two-tone LED (off - red - green) indicates enabling of the VRD. In the welding process:

- MIG MAG (Synergic and Manual) / JOB: the VRD device is not managed and therefore the LED always will be off.
- MMA: the operator can decide whether or not to activate the VRD device (to activate the VRD device see the corresponding paragraph) based on its necessities and therefore the LED will be lit and will indicate the activation of the device.
- TIG Lift: the VRD device is always inserted, independently from the state of the JUMPER and therefore the LED always will be lit.

## ■ WELDING MODE SELECTION LED

When one or a combination of these LED is lit, it means that the corresponding manner of welding has been selected.

## Switching on the welding machine and initial screen

At the switching on of the welder (press the switch, located on the back panel, at the position I), the control performs a short operation of MACHINE CHECK (all of the LED light themselves simultaneously so as to verify their actual operation), and the panel display the INITIAL SCREEN (see the demonstrative figure), after which the operator can begin to work.

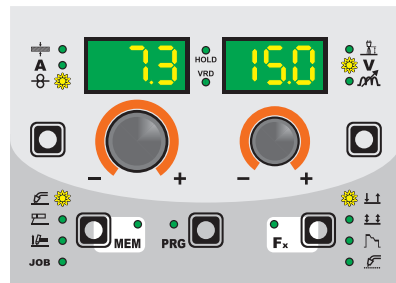

## Viewing the software version installed

- 1) When the welding machine is working hold down the WELDING PROCESS SELECTION key (T2) and WELDING MODE SELECTION key (T3) together for about 2 consecutive seconds.

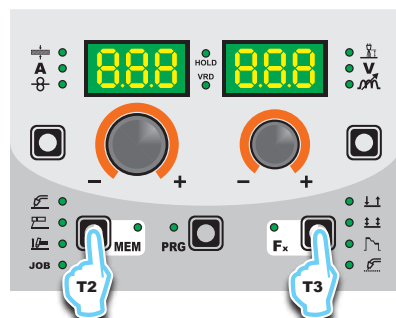

- 2) On both displays appears a running string that indicates the VERSION OF THE SOFTWARE installed on the welder. The rotation of one of the two ENCODER Knobs - A (E1) or V (E2) by the operator during the display of the string version software provokes the block (for 1 second), on both the displays, of the movement of the string itself.



- 3) Ending viewing of the software version on the control panel can come about in 2 different ways:
- Automatically: by waiting for the display time to elapse.
  - Manually: by pushing any key.

## Loading of the wire

In the MIG-MAG-PULSE-DOUBLE PULSE welding processes, with the welder in operation, it is possible to load the wire inside the torch, following this simple procedure:

- Keep the torch button held down.
- After a time of about 2 seconds, the wire begins to load itself at a constant speed.
- This operation is also indicated by a message made up of a numerical value for the wire speed, followed by "LoAd" (see figure).
- Rotate the ENCODER - A (E1) knob to change the wire loading speed.
- To finish the loading of the wire release the torch button.

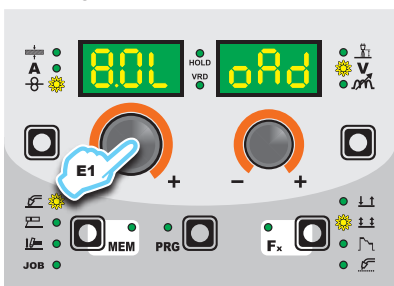

## Special functions "Fx"

To access the SPECIAL FUNCTIONS "Fx" menu, hold the SPECIAL FUNCTIONS "Fx" key (T3) down for at least 3 consecutive seconds. The Fx LED switches on.



The special functions allow the operator to regulate further parameters, operations and do partial resetting, and are operative, in a different way, within each welding process.

Table 1 shows the special functions available. Details of the meaning of the columns are as follows:

- **FUNCTION** column: name of the special function.
- **DISPLAY** column: symbol for the special function (message shown in the PARAMETERS DISPLAY - A screen).
- **FACTORY** column: Factory setting for the special function (message shown in the PARAMETERS DISPLAY - V screen).
- **RANGE** column: regulation field for the special function.
- The last two groups of columns, **WELDING PROCESS** and **MIG-MAG WELDING MODE** indicate the welding process and mode in which the special function can be selected. Example: the SPOT WELD TIME function can be selected only when one is welding in synergistic MIG-MAG-PULSE or manual SPOT 2T mode.

- 1) Rotate the ENCODER - A knob (E1) to select the SPECIAL FUNCTION required. Rotate the ENCODER - V knob (E2) to edit the VALUE for the special function selected.

**WARNING:** Changes to values are immediately activated (no further confirmation is required and they will be displayed immediately) or, at least they will become active the next time welding is done. The operator can edit the functions (not the wire speed and other parameters) when welding is underway and continue welding without having to exit the SPECIAL FUNCTIONS "Fx" menu.

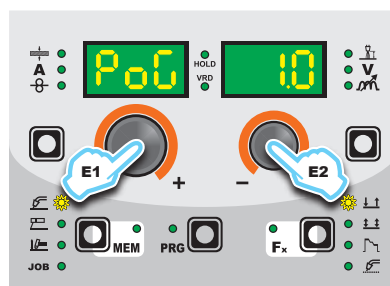

- 2) PROGRAM DEFAULT (dEF)

**WARNING:** If carried out, this operation resets the program in use to the factory default settings.

To carry out the reset of the settings / parameters, proceed in the following manner:

- Rotate the ENCODER - A (E1) knob until both the displays read **dEF no** (see figure).

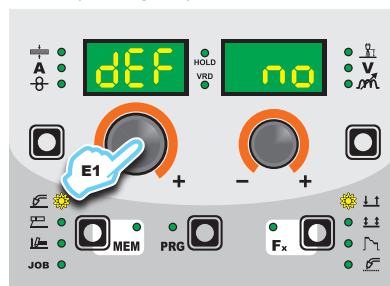

- Rotate the ENCODER - V knob (E2) until the PARAMETERS DISPLAY - V screen (D2) reads **YES**.

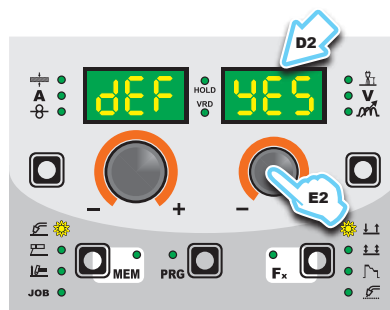

- Hold the SAVE "MEM" key (T2) down for at least 2 consecutive seconds.

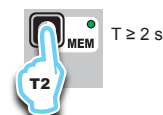

- The program in use has now been completed successfully. To confirmation the above, the control panel of the welder performs a short operation of MACHINE CHECK (all of the LED stay lit simultaneously so as to verify their actual operation), the generator itself starts, having memorised the new settings and is again ready to weld.

Table 1

FUNCTION	DISPLAY	SETTINGS RANGE		WELDING PROCESS				MIG-MAG WELDING MODE								
		FACTORY	RANGE	MIG MAG / PULSE				TIG	MMA	2T	4T	Cra 2T	Cra 4T	Spot 2T	Stitch 2T	Cycle
				MIG PLS CLd	dPL	MAn	SPd									
<b>ADJUSTABLE FUNCTIONS "Fx"</b> <input checked="" type="checkbox"/> Fx > 3s																
<b>MIG-MAG process</b>																
PRE GAS	PrG	0.1s	(0.0 ÷ 2.0)s	•	•	•	•			•	•	•	•	•	•	•
STARTING SPEED	Sts	0	-30 ÷ +30	•	•	•	•			•	•	•	•	•	•	•
HOT START	Hot	0	-30 ÷ +30	•	•	•	•			•	•	•	•	•	•	•
CRATER																
INITIAL CRATER																
CRATER START CURRENT	F08	20%	(-50 ÷ +100)%	•	•		•					•	•			•
CRATER START SPEED	F08	5.0m/min	(1.5 ÷ 22.0)m/min			•						•	•			•
CRATER START VOLTAGE	F09	25.0V	(10.0 ÷ 38.0/42.0)V			•						•	•			•
CRATER START TIME	F10	1.0s	(0.0 ÷ 20.0)s	•	•	•	•					•				
CRATER START SLOPE	F11	1.0s	(0.0 ÷ 20.0)s	•	•	•	•					•	•			•
FINAL CRATER																
CRATER END SLOPE	F12	1.0s	(0.0 ÷ 20.0)s	•	•	•	•					•	•			•
CRATER END CURRENT	F13	-30	(-99 ÷ +50)%	•	•		•					•	•			•
CRATER END SPEED	F13	5.0m/min	(1.5 ÷ 22.0)m/min			•						•	•			•
CRATER END VOLTAGE	F14	25.0V	(10.0 ÷ 38.0/42.0)V			•						•	•			•
CRATER END TIME	F15	0.0s	(0.0 ÷ 20.0)s	•	•	•	•					•				
SPOT WELD TIME	F07	3.0s	(0.1 ÷ 20.0)s	•	•	•	•									•
STITCH WELD																
STITCH WELD TIME	F05	1.0s	(0.1 ÷ 20.0)s	•	•	•	•									•
STITCH WELD PAUSE	F06	1.0s	(0.1 ÷ 20.0)s	•	•	•	•									•
BURN BACK	bUb	0	-30 ÷ +30	•	•	•	•			•	•	•	•	•	•	•
POST GAS	PoG	1.0s	(0.0 ÷ 10.0)s	•	•	•	•			•	•	•	•	•	•	•
CYCLE																
CYCLE CURRENT	F19	20%	(-99 ÷ 100)%	•	•		•									•
CYCLE WIRE SPEED	F19	5.0 m/min	(1.5 ÷ 22.0)m/min			•										•
CYCLE ARC LENGTH	F20	0	-30 ÷ 30	•	•		•									•
CYCLE VOLTAGE	F20	25.0V	(10.0 ÷ 38.0/42.0)V			•										•
DUAL PULSE FUNCTIONS																
DUAL PULSE DELTA CURRENT	F23	50%	(-99 ÷ +200)%		•					•	•	•	•	•	•	•
DUAL PULSE BALANCE	F25	0%	(-40 ÷ +40)%		•					•	•	•	•	•	•	•
DUAL PULSE FREQUENCY	F26	2.7Hz	(0.1 ÷ 5)Hz		•					•	•	•	•	•	•	•
DYNAMICS	dYn	0	-30 ÷ 30				•			•	•	•	•	•	•	•
<b>TIG process</b>																
UP SLOPE	F29	0.0s	(0.0 ÷ 20.0)s					•								
DOWN SLOPE	F30	2.0s	(0.0 ÷ 20.0)s					•								
SWS VOLTAGE LIMIT	F31	0	-30 ÷ 30					•								
<b>MMA process</b>																
HOT START	Hot	50	0 ÷ 100						•							
ARC FORCE	ArC	50	0 ÷ 100						•							
PROGRAM DEFAULT	dEF	no	no - YES	•	•	•	•	•	•	•	•	•	•	•	•	•

<b>SETUP (SEtUP) menu</b> <input checked="" type="checkbox"/> PRG > 3s																
FACTORY DEFAULT	FAC	no	no - YES	•	•	•	•	•	•	•	•	•	•	•	•	•
TIMER ARC ON	ArC ont			•	•	•	•	•	•	•	•	•	•	•	•	•
TIMER WELDING MACHINE ON	tiM Eon			•	•	•	•	•	•	•	•	•	•	•	•	•
ERROR LOG	Err Log			•	•	•	•	•	•	•	•	•	•	•	•	•
TEST	tES t			•	•	•	•	•	•	•	•	•	•	•	•	•

<b>SPECIAL FUNCTIONS (SPC FnC) menu</b> <input checked="" type="checkbox"/> PRG > 3s																
SAFETY CALIBRATION CODE	SCC	7	0 ÷ 100	•	•	•	•			•	•	•	•	•	•	•
MOTOR CALIBRATION	Mot CAL															
SPEED MOTOR 1	SM1	75.0	50.0 ÷ 99.9	•	•	•	•			•	•	•	•	•	•	•
SPEED MOTOR 2	SM2	75.0	50.0 ÷ 99.9	•	•	•	•			•	•	•	•	•	•	•
SPEED MOTOR 3	SM3	75.0	50.0 ÷ 99.9	•	•	•	•			•	•	•	•	•	•	•
ARC LENGTH ADJUST	ArC	U	U - rPM	•	•	•	•			•	•	•	•	•	•	•
CYCLE	CYC	oFF	oFF - on	•	•	•	•			•	•	•	•	•	•	•
WATER COOLING MODE	H2o	Dem	Dem - Aon	•	•	•	•	•	•	•	•	•	•	•	•	•
PASSWORD	PAS	0	0 ÷ 999	•	•	•	•	•	•	•	•	•	•	•	•	•
BLOCKS	bLC	no	no - L1 - L2 - L3	•	•	•	•	•	•	•	•	•	•	•	•	•
SERIAL NUMBER	SEr nUM			•	•	•	•	•	•	•	•	•	•	•	•	•

- To exit the SPECIAL FUNCTIONS “Fx” menu, push and release the SPECIAL FUNCTIONS “Fx” (T3) key once.

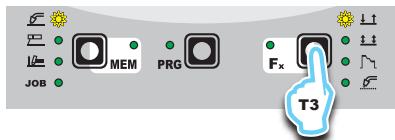

## SETUP Menu

Hold the PRG key down for at least 3 seconds to open the SET-UP menu, which provides access to various functions, which are suitable for expert operators, such as advanced configurations, system tests, and calibrations. For further information, see table 1.

### FACTORY DEFAULT (FAC)

**WARNING:** If carried out, this operation results in complete resetting of all editable parameters to the factory settings (including cancellation of the JOBS).

To carry out the reset of the settings / parameters, proceed in the following manner:

- Rotate the ENCODER - A (E1) knob until both the displays read **FAC no** (see figure).

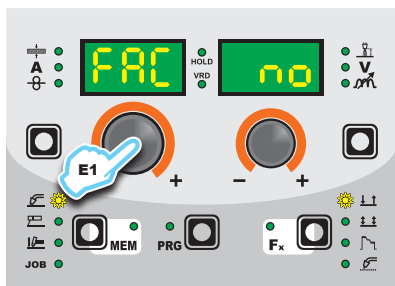

- Rotate the ENCODER - V knob (E2) until the PARAMETERS DISPLAY - V screen (D2) reads **YES**.

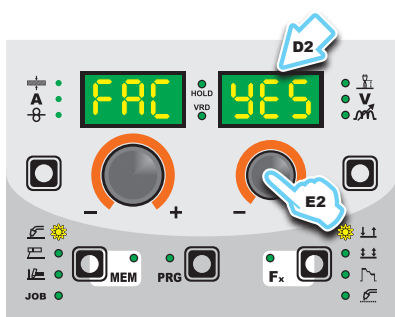

- Hold the SAVE “MEM” key (T2) down for at least 2 consecutive seconds.

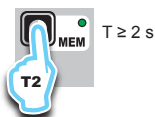

- At this stage the **total reset** or **factory default** procedure has been completed successfully (the parameters have been taken back to the factory values and any JOBS saved have been deleted). To confirm the above, the control panel of the welder performs a short operation of MACHINE CHECK (all of the LED stay lit simultaneously so as to verify their actual operation), the generator itself starts, having memorised the new settings and is again ready to weld.

### TIMER ARC ON

This indicates the actual time the machine was used for welding.

**WARNING:** This time can only be zeroed using the **FACTORY DEFAULT (FAC in the SETUP menu)** for the welding plant.

- Rotate the ENCODER - A (E1) knob, until both the displays (D1-D2) read **ArCont**.

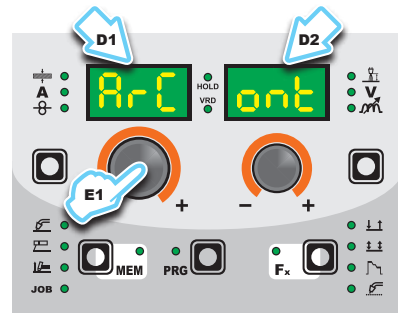

- Push the **PRG** key to view the welding use time, expressed in DAYS (d), HOURS (H), MINUTES (M). Example: 2d-3H-25M.

2d-3H-25M

- To go back to the **SETUP** menu, push the SAVE “MEM” (T2) key.



### TIMER WELDING MACHINE ON

This indicates the time the welding machine was switched on.

**WARNING:** This time can only be zeroed using the **FACTORY DEFAULT (FAC in the SETUP menu)** for the welding plant.

- Rotate the ENCODER - A (E1) knob, until both the displays (D1-D2) read **tiMEon**.

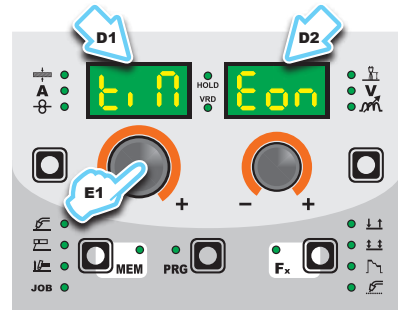

- Push the **PRG** key to view the time the welding machine was switched on, expressed in DAYS (d), HOURS (H), MINUTES (M). Exam-ple: 120d-13H-22M.

120d-13H-22M

- To go back to the **SETUP** menu, push the SAVE “MEM” (T2) key.



## ERROR LOG

This allows the operator to know about the error states that have arisen on the welding plant.

- 1) Rotate the ENCODER - A (E1) knob, until both the displays (D1-D2) read **Err Log**.

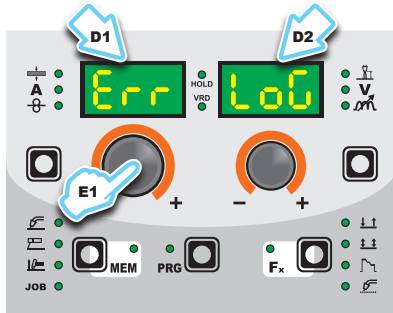

- 2) Push the **PRG** key (T5), and the display will show the error code under DISPLAY PARAMETERS - A (D1), and the number of times under DISPLAY PARAMETERS - V (D2). For the code error, see the list contained in the "Error Conditions" paragraph.

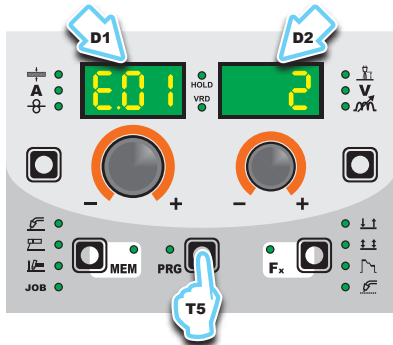

- 3) Rotate the ENCODER - V (E2) knob to scroll the list.
- 4) To go back to the **SEtUP** menu, push the SAVE "MEM" (T2) key.



- 5) To exit the **SEtUP** menu, push the SAVE "MEM" (T2) key again.



## TEST

This configuration allows the operator to check that some functions of some devices.

- 1) Rotate the ENCODER - A (E1) knob, until both the displays (D1-D2) read **tEst**.

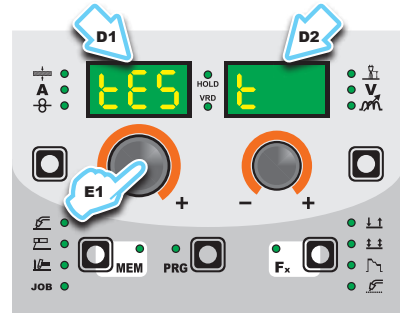

- 2) Push the **PRG** key (T5), and the display will show the parameter to be checked under DISPLAY PARAMETERS - A (D1), and the set-ting under DISPLAY PARAMETERS - V (D2).

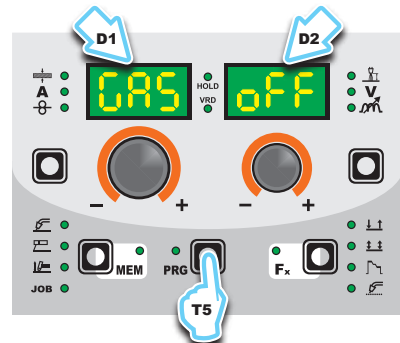

- 3) Rotate the ENCODER - A (E1) knob to select the device to be tested, from **GAS** (solenoid valve), **MoT** (wire feeder motor), **FAn** (fans) and **H2o** (cooling unit, only if fitted).
- 4) Rotate the ENCODER - V (E2) knob clockwise to go from the oFF state to the on state, which activates the device and allows the user to check it is working.

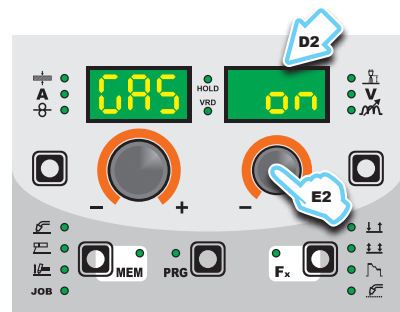

- 5) To go back to the **oFF** state, rotate the ENCODER - V (E2) knob anticlockwise.
- 6) Push the SAVE "MEM" (T2) key to go back to the **SEtUP** menu.



- 7) To check another device, repeat steps 2, 3 and 4.
- 8) To exit the **SEtUP** menu, push the SAVE "MEM" (T2) key again.



## Menu SPECIAL FUNCTIONS

From the **SETUP** menu, push the **PRG** key (T5) for more than 3 seconds to access the **SPECIAL FUNCTIONS** menu, which provides access to additional functions that can only be managed by an expert, responsible operator. The two displays (D1-D2) will read **SPC FnC**.

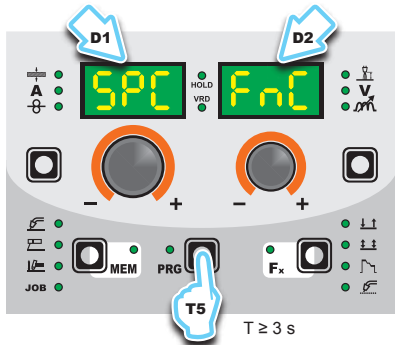

## SAFETY CALIBRATION CODE (SCC)

**ATTENTION:** This operation, if carried on, optimizes the efficiency of the welding circuit (only in MIG welding processes).

To set the length of the welding circuit (adjustable from 1 to 100 m) follow this procedure:

- Rotate the **ENCODER** knob - A (E1) until obtaining on the **PARAMETER DISPLAY** screen - A (D1) and the writing **SCC**.
- Rotate the **ENCODER** knob - V (E2) until obtaining on the **PARAMETER DISPLAY** screen - V (D2) the desired number.

**CAUTION:** The operation does not require confirmation!

**CAUTION:** The data inserted is valid for all the MIG welding processes.

Example:

Length of cable mass 3 m.

Length of welding torch cable 3 m.

The overall length of the welding circuit is 6 m (6 is the number that will therefore be inserted).

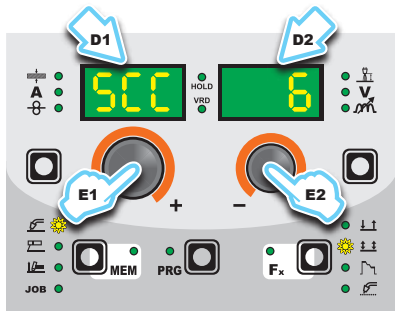

## MOTOR CALIBRATION (Mot CAL)

**ATTENTION:** This procedure allows you to calibrate the wire speed (only in MIG welding processes).

Proceed as follows:

- Rotate the **ENCODER** - A (E1) knob until the **PARAMETER DISPLAY** - A (D1) screen reads **Mot CAL**.

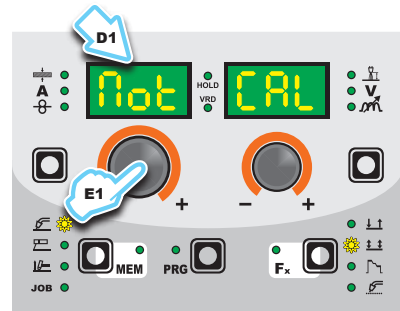

- To open the **CALIBRATION** menu, push the **PRG** key (T5).



- The procedure of calibration is carried out in 3 different phases:

### 1. Calibration parameter SM1 (MINIMUM SPEED)

Push and release the torch button, and then wait for the wire to stop automatically, and the **End MiS** message to appear. Measure (in cm) the dangling wire and insert the value shown, in the software of the welder, by means of the rotation of the **ENCODER** knob - V (E2) appearing on the **PARAMETER DISPLAY** screen - V (D2) is the desired value.

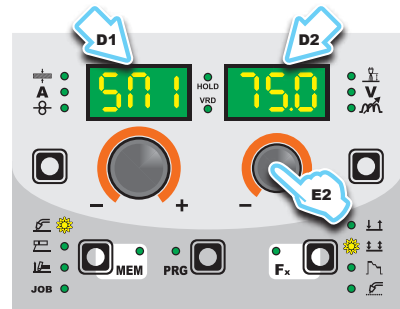

### 2. Calibration parameter SM2 (MEDIUM SPEED)

Then turn the **ENCODER** - A knob (E1) until the **PARAMETER DISPLAY** - A screen (D1) shows the **SM2** parameter. Push and release the torch button, and then wait for the wire to stop automatically, and the **End MiS** message to appear. Measure (in cm) the dangling wire and insert the value shown, in the software of the welder, by means of the rotation of the **ENCODER** knob - V (E2) appearing on the **PARAMETER DISPLAY** screen - V (D2) is the desired value.

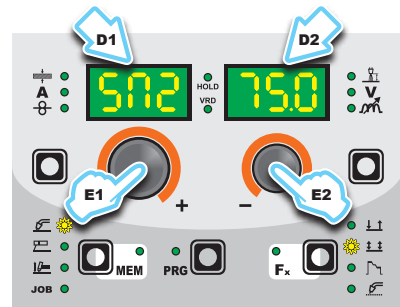

### 3. Calibration parameter SM3 (MAXIMUM SPEED)

Then turn the ENCODER - A knob (E1) until the PARAMETER DISPLAY - A screen (D1) shows the **SM3** parameter. Push and release the torch button, and then wait for the wire to stop automatically, and the **End MiS** message to appear. Measure (in cm) the dangling wire and insert the value shown, in the software of the welder, by means of the rotation of the ENCODER knob - V (E2) appearing on the PARAMETER DISPLAY screen - V (D2) is the desired value.

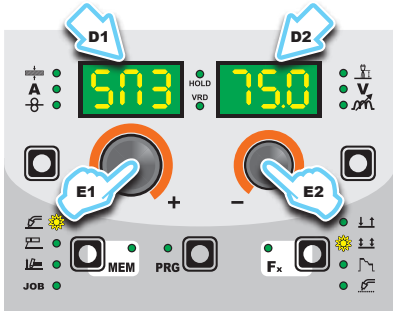

- At the end of the procedure, the software present in the welder will immediately re-calculate the characteristic curve of the engine, rendering it suitable to use.
- To exit from the CALIBRATION menu, press and release the SAVE "MEM" key (T2).



- To interrupt measuring, push the SAVE "MEM" (T2) Key.

### ARC LENGTH ADJUST

For MIG welding processes (pulsed, double pulsed, synergic, and manual), this function allows the operator to adjust the ARC LENGTH ADJUST (⚡) parameter, with the WELDING VOLTAGE (V) or the WIRE SPEED (⚡).

- 1) Rotate the ENCODER - A (E1) knob until the DISPLAY PARAMETERS - A (D1) display shows the **ArC** function, and the DISPLAY PARAMETERS - V (D2) display shows the two adjustment methods: **U** (VOLT - WELDING VOLTAGE) and **rPM** (SPEED - WIRE SPEED).
- 2) Rotate the ENCODER - V (E2) knob and choose the adjustment method required (this operation does not need to be confirmed).

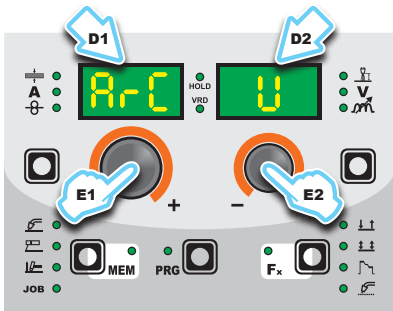

- 3) To change the adjustment method, repeat steps 1 and 2.
- 4) To exit the **SEtUP** menu, push the SAVE "MEM" (T2) key.



### CYCLE

If enabled, this function allows the operator to have a further welding mode (CYCLE) available, in MIG (pulsed, double pulsed, synergic and manual) welding processes, as well as the special functions associated with it:

- CURRENT CYCLE, CYCLE WIRE SPEED (see Table 1, Parameter F19).
- CYCLE ARC LENGTH, CYCLE VOLTAGE (see Table 1, Parameter F20).

- 1) Rotate the ENCODER - A (E1) knob until the DISPLAY PARAMETERS - A (D1) display shows the **CYC** function, and the DISPLAY PARAMETERS - V (D2) display shows the two choices available: **oFF** (cycle disabled) and **oN** (cycle enabled).
- 2) Rotate the ENCODER - V (E2) knob and choose whether to enable or disable the cycle (this operation does not need to be confirmed).

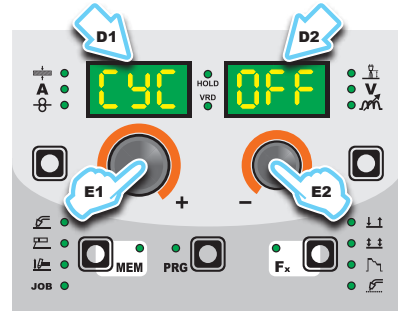

- 3) To change the mode, repeat steps 1 and 2.
- 4) To exit the **SEtUP** menu, push the SAVE "MEM" (T2) key twice.



### WATER COOLING MODE

This configuration allows the operator to set cooling (only if available), in the following ways:

- ON DEMAND - In this case, cooling is managed in relation to the welding done.
- ALWAYS ON - In this case, cooling comes on when the machine is switched on, and stays on until the machine is switched off. Cooling only stops when an alarm is activated.

To make the setting, proceed as follows:

- 1) Rotate the ENCODER - A (E1) knob until the DISPLAY PARAMETERS - A (D1) display shows the **H2o** function, and the DISPLAY PARAMETERS - V (D2) display shows the two choices available: **Dem** (ON DEMAND) and **Aon** (ALWAYS ON).
- 2) Rotate the ENCODER - V (E2) knob and choose the cooling mode required (this operation does not need to be confirmed).

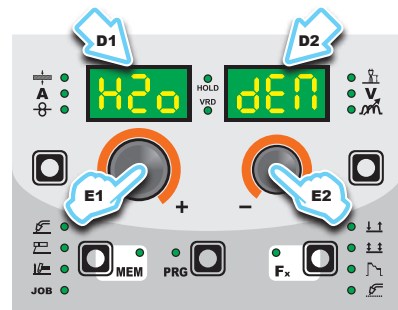



- 3) To change the mode, repeat steps 1 and 2.
- 4) To exit the **SETUP** menu, push the SAVE "MEM" (T2) key twice.



### PASSWORD

The **SETUP** Menu can be protected by entering a personalised user password.

- 1) Rotate the ENCODER - A (E1) knob, until both the displays (D1-D2) read **PAS 0**, which indicates that no password has been entered.

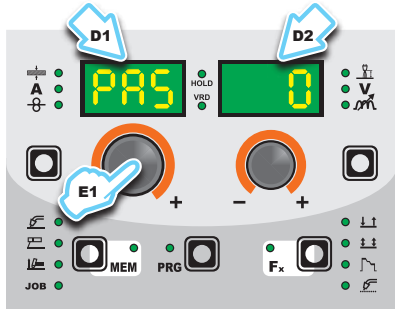

- 2) Rotate the ENCODER - V (E2) knob until the DISPLAY PARAMETERS V (D2) display shows the number required (from 0 to 999) (this operation does not need to be confirmed).

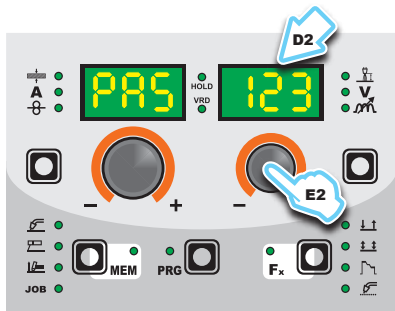

- 3) Once a PASSWORD has been entered, each time the **SETUP** Menu is accessed, to be able to use it the correct number must be set and confirmed by pushing the PRG key.
- 4) To change the PASSWORD, repeat steps 2 and 3.
- 5) To exit the **SETUP** menu, push the SAVE "MEM" (T2) key twice.



**IMPORTANT:** If the password is lost, contact CEA's technical service department.

### BLOCKS

If enabled, this function allows the operator to block or limit use of the welding machine and/or certain welding parameters / functions. There are 4 possible options to choose from:

- **BLOCK no** - Does not allow any block to be activated for the welding machine, but allows the operator to unblock the machine if it was blocked in the past.
- **BLOCK L1** - The operator can only weld using the parameters set prior to the block, and can set and/or modify the welding parameters, using the knobs on the control panel on the welding machine and the wire feeder (if installed).
- **BLOCK L2** - The operator can only weld using the parameters set prior to the block and cannot set and/or modify the welding parameters.
- **BLOCK L3** - Allows the voltage, current, and electronic inductance value to be corrected by  $\pm 15\%$ .

- 1) Rotate the ENCODER - A (E1) knob until the DISPLAY PARAMETERS - A (D1) display reads **bLC** and the DISPLAY PARAMETERS - V (D2) display shows the four choice options of: **no** (NO BLOCK), **L1** (PARTIAL BLOCK), **L2** (TOTAL BLOCK), **L3** (PERSONALISED BLOCK).
- 2) Rotate the ENCODER - V (E2) knob and choose one of the 4 options (this operation does not need to be confirmed).

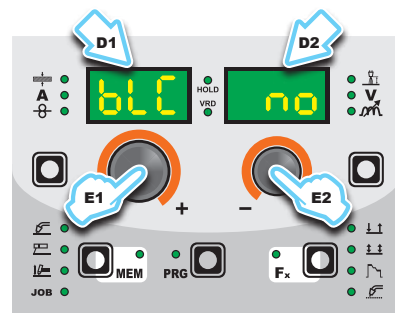

- 3) To change the mode, repeat steps 1 and 2.
- 4) To exit the **SETUP** menu, push the SAVE "MEM" (T2) key twice.



### SERIAL NUMBER

This function provides the serial number for the control board, which is of use for technical assistance.

- 1) Rotate the ENCODER - A (E1) knob until the DISPLAY PARAMETERS - A (D1) display shows the **SEr** function, and the DISPLAY PARAMETERS - V (D2) display reads **nUM**.

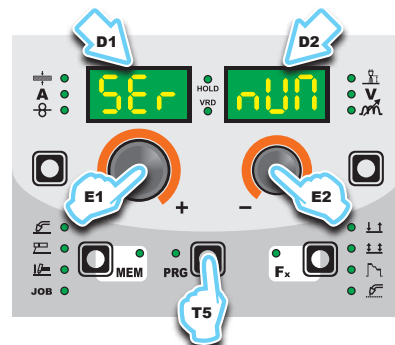

- 2) When the PRG key is pushed, a 16-character text will pass by, indicating the board's serial number.

# MIG-MAG synergic / MIG pulse / double pulsed MIG

Start the welder by pressing the switch, located on the back panel, at the position I.

## 1 - WELDING PROCESS SELECTION

Select the MIG welding PROCESS this way:

- 1) Push the SELECT WELDING PROCESS (T2) key, even a number of times if necessary, until the corresponding LED switches on.

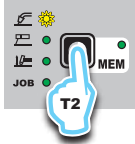

- 2) Push the SELECT PROGRAM key (T5). The corresponding LED switches on.



- 3A) To access the MIG-MAG synergic welding process: rotate the ENCODER knob - A (E1) until obtaining on the PARAMETER DISPLAY screen - A (D1) and the writing **MIG**.

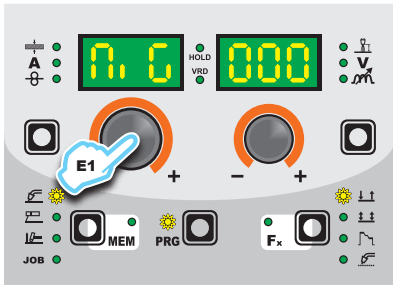

- 3B) To access the MIG pulse welding process: rotate the ENCODER knob - A (E1) until obtaining on the PARAMETER DISPLAY screen - A (D1) and the writing **PLS**.

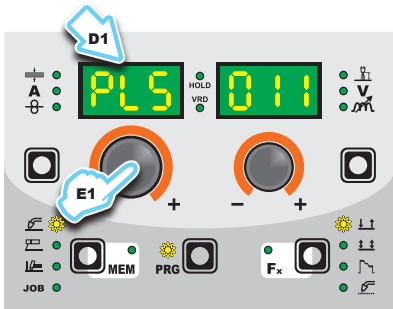

- 3C) To access the double pulsed MIG welding process: rotate the ENCODER knob - A (E1) until obtaining on the PARAMETER DISPLAY screen - A (D1) and the writing **dPL**.

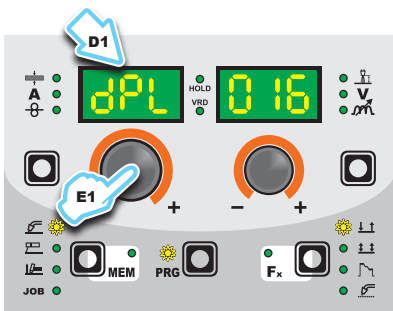

- 3D) To access the vision.COLD welding process: rotate the ENCODER knob - A (E1) until obtaining on the PARAMETER DISPLAY screen - A (D1) and the writing **CLd**.

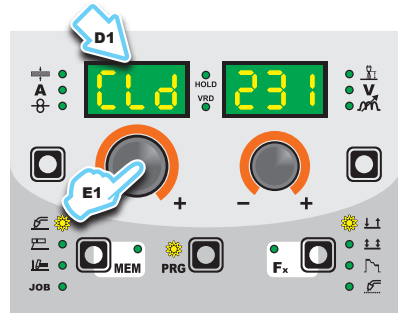

- 3E) (excluding CONVEX MOBILE 251 and CONVEX MOBILE 255 PULSE models) To access the vision.ULTRASPEED welding process: rotate the ENCODER knob - A (E1) until obtaining on the PARAMETER DISPLAY screen - A (D1) and the writing **SPd**.

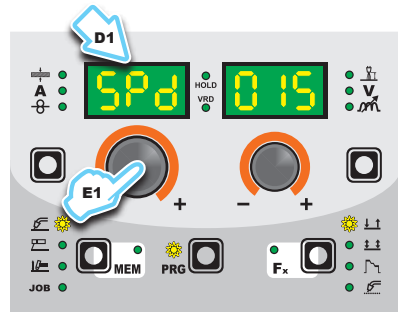

## 2 - SELECTION OF WELDING PROGRAMME

PROGRAM TABLE										
MIG MAG (MIG MAG) - PULSE (PLS) - DUAL PULSE (dPL) - VISION.COLD (CLd) - VISION.ULTRASPEED (SPd) - EXTENDED CURVES PACKAGE (ECP)										
PROGRAM NUMBER	MATERIAL		WIRE Ø (mm)	GAS	MIG MAG	PLS dPL	ECP MIG MAG	ECP PLS dPL	CLd	SPd
000	Fe	G3 Si-1	0.6	CO2	#	#	#	#	#	#
001	Fe	G3 Si-1	0.8	CO2	#	#	#	#	#	#
002	Fe	G3 Si-1	1.0	CO2	#	#	#	#	#	#
003	Fe	G3 Si-1	1.2	CO2	#	#	#	#	#	#
005	Fe	G3 Si-1	0.9	CO2	#	#	#	#	#	#
010	Fe	G3 Si-1	0.8	Ar/18-20%CO2	#	#	#	#	#	#
011	Fe	G3 Si-1	0.8	Ar/18-20%CO2	#	#	#	#	#	#
012	Fe	G3 Si-1	1.0	Ar/18-20%CO2	#	#	#	#	#	#
013	Fe	G3 Si-1	1.2	Ar/18-20%CO2	#	#	#	#	#	#
016	Fe	G3 Si-1	0.9	Ar/18-20%CO2	#	#	#	#	#	#
021	Fe	G3 Si-1	0.8	Ar/11-15%CO2	#	#	#	#	#	#
022	Fe	G3 Si-1	1.0	Ar/11-15%CO2	#	#	#	#	#	#
023	Fe	G3 Si-1	1.2	Ar/11-15%CO2	#	#	#	#	#	#
031	Fe	G3 Si-1	0.8	Ar/8-10% CO2	#	#	#	#	#	#
032	Fe	G3 Si-1	1.0	Ar/8-10% CO2	#	#	#	#	#	#
033	Fe	G3 Si-1	1.2	Ar/8-10% CO2	#	#	#	#	#	#
041	Fe	G3 Si-1	0.8	Ar/2-3% CO2	#	#	#	#	#	#
042	Fe	G3 Si-1	1.0	Ar/2-3% CO2	#	#	#	#	#	#
043	Fe	G3 Si-1	1.2	Ar/2-3% CO2	#	#	#	#	#	#
051	Fe	G3 Si-1	0.8	Ar/21-25% CO2	#	#	#	#	#	#
052	Fe	G3 Si-1	1.0	Ar/21-25% CO2	#	#	#	#	#	#
053	Fe	G3 Si-1	1.2	Ar/21-25% CO2	#	#	#	#	#	#
055	Fe	G3 Si-1	0.9	Ar/21-25% CO2	#	#	#	#	#	#
063	Fe	G62 4M Mn3NiCrMo	1.2	Ar/18-20%CO2	#	#	#	#	#	#
072	Fe	G3 Si-1	1.0	Ar CO2 50	#	#	#	#	#	#
073	Fe	G3 Si-1	1.2	Ar CO2 50	#	#	#	#	#	#
082	Fe	MAGNETIC CORRECTION	1.0	Ar CO2 50	#	#	#	#	#	#
103	FCW RUTIL	142 2	1.2	Ar/18-20% CO2	#	#	#	#	#	#
113	FCW RUTIL	142 2	1.2	Ar/18-20% CO2	#	#	#	#	#	#
123	FCW RUTIL	142 2	1.2	Ar/18-20% CO2	#	#	#	#	#	#
143	FCW BASIC	142 4	1.2	Ar/18-20% CO2	#	#	#	#	#	#
163	FCW METAL	142 2	1.2	Ar/18-20% CO2	#	#	#	#	#	#
173	FCW METAL	142 2	1.2	Ar/18-10% CO2	#	#	#	#	#	#
193	SUBMERGED ARC	Fe 32	1.2	WEL 1 FLUX	#	#	#	#	#	#
201	CrNi 316	G19 12 3	0.8	Ar/2-3%CO2	#	#	#	#	#	#
202	CrNi 316	G19 12 3	1.0	Ar/2-3%CO2	#	#	#	#	#	#
203	CrNi 316	G19 12 3	1.2	Ar/2-3%CO2	#	#	#	#	#	#
213	CrNi 310	G26 20	1.2	Ar/2-3%CO2	#	#	#	#	#	#
222	CrNi 309	G23-12	1.0	Ar/2-3%CO2	#	#	#	#	#	#
223	CrNi 309	G23-12	1.2	Ar/2-3%CO2	#	#	#	#	#	#
231	CrNi 308	G19 9	0.8	Ar/2-3%CO2	#	#	#	#	#	#
232	CrNi 308	G19 9	1.0	Ar/2-3%CO2	#	#	#	#	#	#
233	CrNi 308	G19 9	1.2	Ar/2-3%CO2	#	#	#	#	#	#
241	CrNi 307	G18 8	0.8	Ar/2-3%CO2	#	#	#	#	#	#
242	CrNi 307	G18 8	1.0	Ar/2-3%CO2	#	#	#	#	#	#
243	CrNi 307	G18 8	1.2	Ar/2-3%CO2	#	#	#	#	#	#
253	CrNi 385	G20 25 5	1.2	Ar/2-3%CO2	#	#	#	#	#	#
303	FCW 316	T19 12 3	1.2	Ar/18-20% CO2	#	#	#	#	#	#
313	FCW 309	T23 12	1.2	Ar/18-20% CO2	#	#	#	#	#	#
343	FCW 309	T23 12	1.2	Ar/21-25% CO2	#	#	#	#	#	#
353	FCW 308H	T19 9	1.2	Ar/21-25% CO2	#	#	#	#	#	#
402	Al 99.5	Al 1050	1.0	Ar 99.9%	#	#	#	#	#	#
403	Al 99.5	Al 1050	1.2	Ar 99.9%	#	#	#	#	#	#
412	Al Mg 5	S Al 5356	1.0	Ar 99.9%	#	#	#	#	#	#
413	Al Mg 5	S Al 5356	1.2	Ar 99.9%	#	#	#	#	#	#
422	Al Si 5	S Al 4043A	1.0	Ar 99.9%	#	#	#	#	#	#
423	Al Si 5	S Al 4043A	1.2	Ar 99.9%	#	#	#	#	#	#
433	Al Mg 4.5	S Al 5087/5183	1.2	Ar 99.9%	#	#	#	#	#	#
443	Al Mg 5	S Al 5356	1.2	Ar 99.9%	#	#	#	#	#	#
453	Al Si 5	S Al 4043A	1.2	Ar 99.9%	#	#	#	#	#	#
463	Al 99.5	S Al 5356	1.2	Ar/30-50% He	#	#	#	#	#	#
483	Al Mg 4.5	S Al 5087/5183	1.2	Ar/30-50% He	#	#	#	#	#	#
511	BRAZING	S Cu Si3	0.8	Ar 99.9%	#	#	#	#	#	#
512	BRAZING	S Cu Si3	1.0	Ar 99.9%	#	#	#	#	#	#
513	BRAZING	S Cu Si3	1.2	Ar 99.9%	#	#	#	#	#	#
515	BRAZING	S Cu Si3	0.8	Ar 99.9%	#	#	#	#	#	#
525	BRAZING	S Cu Al8	0.8	Ar 99.9%	#	#	#	#	#	#
526	BRAZING	S Cu Al8	1.0	Ar 99.9%	#	#	#	#	#	#
527	BRAZING	S Cu Al8	1.2	Ar 99.9%	#	#	#	#	#	#
528	BRAZING	S Cu Al8	1.0	Ar 99.9%	#	#	#	#	#	#
541	BRAZING	S Cu Si3	0.8	Ar/1-2% CO2	#	#	#	#	#	#
542	BRAZING	S Cu Si3	1.0	Ar/1-2% CO2	#	#	#	#	#	#
543	BRAZING	S Cu Si3	1.2	Ar/1-2% CO2	#	#	#	#	#	#
553	BRAZING	S Cu Si3	0.8	Ar 99.9%	#	#	#	#	#	#
563	CuNi30Fe	Cu 7158	1.2	Ar 99.9%	#	#	#	#	#	#
573	BRAZING	Cu Sn	1.2	Ar 99.9%	#	#	#	#	#	#
603	INCONEL	ERNICrMo3	1.2	Ar 99.9%	#	#	#	#	#	#
613	H.FACING INCONEL	ERNICrMo3	1.2	Ar 99.9%	#	#	#	#	#	#
663	FLUX METAL	CrMo	1.2	Ar/2-3% CO2	#	#	#	#	#	#
703	DUPLEX	ER2209	1.0	Ar/2-3% CO2	#	#	#	#	#	#
705	DUPLEX	ER2209	1.2	Ar/2-3% CO2	#	#	#	#	#	#
723	SUPER DUPLEX	ER2594	1.2	Ar/2-3% CO2	#	#	#	#	#	#
733	SUPER DUPLEX	ER2594	1.2	Ar He CO2	#	#	#	#	#	#

**WARNING:** This table is merely an example, the welding programs can be updated and extended. See the table on the welding machine for the correct list of the programs available.

Select the welding PROGRAMME rotating ENCODER knob - V (E2) until obtaining on the PARAMETER DISPLAY screen - V (D2) the desired number.

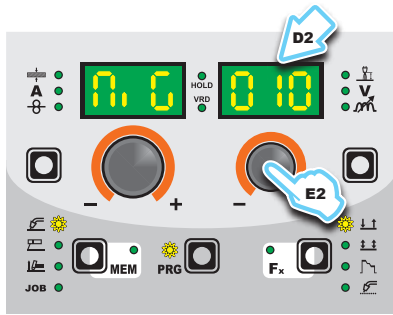

### 3 - WELDING MODE SELECTION

Select the MODE of welding, pressing and releasing, even various times if necessary, the WELDING MODE SELECTION key (T3) until the corresponding LED lights up.

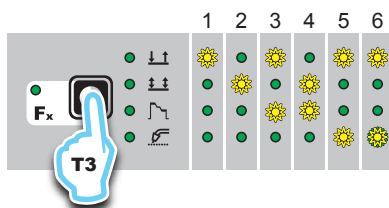

1. TWO STROKE (2T)
2. FOUR STROKE (4T)
3. CRATER 2T
4. CRATER 4T
5. SPOT WELDING 2T
6. STITCH WELDING 2T

### 4 - SPECIAL FUNCTIONS "Fx" SELECTION

The SPECIAL FUNCTIONS "Fx" that are only available in the synergic MIG-MAG and pulsed / double pulsed MIG welding process are shown below. For all the other explanations regarding this menu make reference to the relative paragraph.

- **PRE GAS (PrG)** - Provides an additional quantity of gas for a defined time, before welding starts.
- **STARTING SPEED (StS)** - Regulates the speed at which the wire approaches the workpiece. The value indicated is a percentage variation in relation to the factory setting value.
- **HOT START (Hot)** - Regulates the current intensity for igniting the welding arc. The value indicated is a percentage variation in relation to the factory setting value.
- **CRATER START CURRENT (F08)** - Sets the initial starting current of the crater.
- **CRATER START TIME (F10)** - This function defines the time in which the current remains at the value of CRATER START CURRENT.
- **CRATER START SLOPE (F11)** - The time lapse for passing from the CRATER START CURRENT level to the welding current level.
- **CRATER END SLOPE (F12)** - Time required to go from the welding current level to the "CRATER END CURRENT" level.
- **CRATER END CURRENT (F13)** - Sets the final welding current of the crater.
- **CRATER END TIME (F15)** - This function defines the time in which the current remains at the value of CRATER END CURRENT.
- **SPOT WELD TIME (F07)** - The time during which spot welding takes place after the arc is ignited, after which the arc is extinguished automatically.
- **STITCH WELD TIME (F05)** - Time in which the welding in tracts is performed after the ignition of the arch, after which the arch switches off automatically.
- **STITCH WELD PAUSE (F06)** - Time of pause between one welding in tracts and another.
- **BURN BACK (bUb)** - Regulates the length of the wire after welding. The value indicated is a percentage variation in relation to

the factory setting value. Higher numbers correspond to more burning of the wire.

- **POST GAS (PoG)** - Provides an additional quantity of gas for a defined time, after welding ends.
- **DUAL PULSE DELTA CURRENT (F23)** - This function determines the positive or negative percentage variation in the peak current, compared to the welding current set.
- **DUAL PULSE BALANCE (F25)** - This function determines the positive or negative percentage variation in the duration of the peak current, compared to that of the welding current.
- **DUAL PULSE FREQUENCY (F26)** - This function determines the variation in frequency (Hz) for double pulsed mode.
- **CYCLE CURRENT (F19)** - This function determines the positive or negative variation in cycle current, compared to the welding current set (only available if CYCLE is enabled in the SETUP).
- **CYCLE ARC LENGTH (F20)** - This function determines the variation in the cycle arc length, compared to the standard length (only available if CYCLE is enabled in the SETUP).

### PROGRAM DEFAULT (dEF)

**WARNING:** If carried out, this operation resets the program in use to the factory default settings.

To carry out the reset of the settings / parameters, proceed in the following manner:

- Rotate the ENCODER - A (E1) knob until both the displays read **dEF no** (see figure).

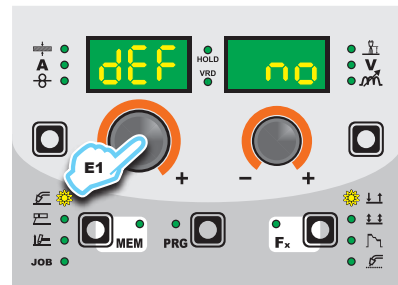

- Rotate the ENCODER - V knob (E2) until the PARAMETERS DISPLAY - V screen (D2) reads **YES**.

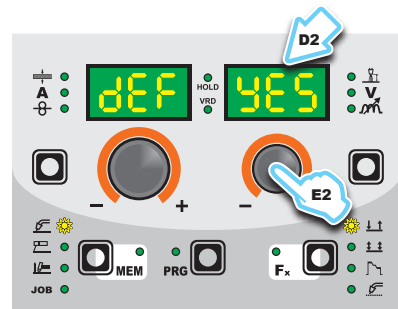

- Hold the SAVE "MEM" key (T2) down for at least 2 consecutive seconds.



- The program in use has now been completed successfully. To confirmation the above, the control panel of the welder performs a short operation of MACHINE CHECK (all of the LED stay lit simultaneously so as to verify their actual operation), the generator itself starts, having memorised the new settings and is again ready to weld.

## 5 - PRE-SETTING

Before welding it is possible to set the following parameters:

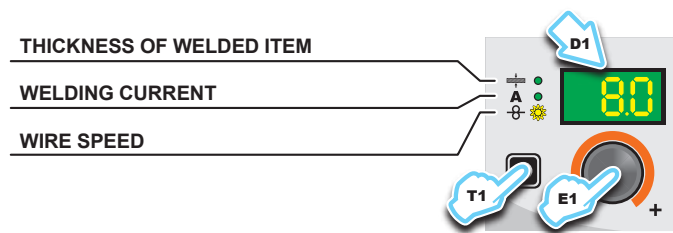

Example: WIRE SPEED

Press the PARAMETER SELECTION - A key (T1) until the LED that corresponds to the WIRE SPEED switches on. Turn the ENCODER - A knob (E1) to change the value shown on the PARAMETER DISPLAY - A screen (D1).

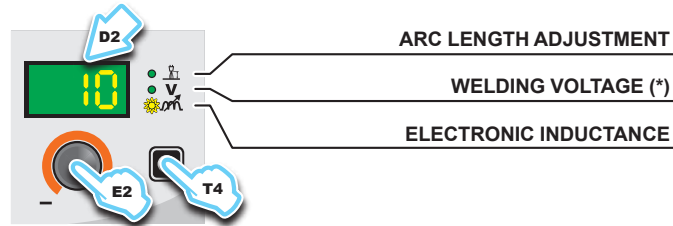

(\*) The parameter is pre-set by means of synergy and can be changed by varying the ARC LENGTH ADJUSTMENT parameter.

Example: ELECTRONIC INDUCTANCE

Press the PARAMETER SELECTION - V key (T4) until the LED that corresponds to the ELECTRONIC INDUCTANCE switches on. Turn the ENCODER - V knob (E2) to change the value shown on the PARAMETER DISPLAY - V screen (D2).

## 6 - WELDING

During the welding the display shows:

- PARAMETER DISPLAY screen - A (D1)

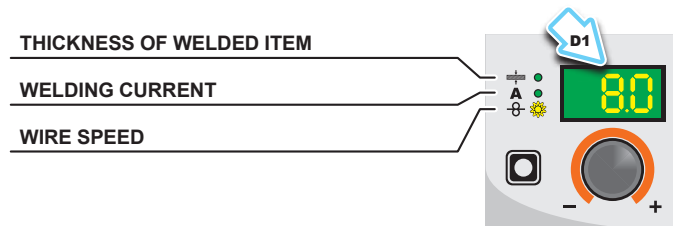

- THICKNESS OF WELDED ITEM ( $\equiv$ ): the value previously set.
- WELDING CURRENT (**A**): the measured value of the current of what is being welded.
- WIRE SPEED ( $\omin�$ ): the value previously set.
- PARAMETER DISPLAY screen - V (D2)

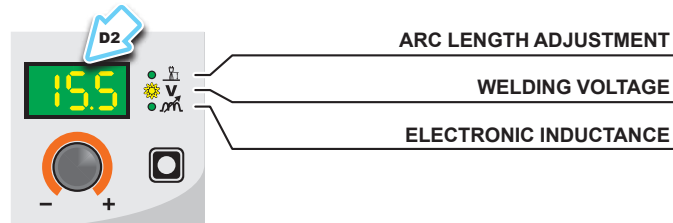

- ARC LENGTH ADJUSTMENT ( $\downarrow$ ): the value previously set.
- WELDING VOLTAGE (**V**): the measured value of the voltage of what is being welded.
- ELECTRONIC INDUCTANCE ( $\mu$ ): the value previously set.

During the welding the operator can change the following parameters:

- THICKNESS OF WELDED ITEM ( $\equiv$ ).
- WELDING CURRENT (**A**).
- WIRE SPEED ( $\omin�$ ).
- ARC LENGTH ADJUSTMENT ( $\downarrow$ ).
- ELECTRONIC INDUCTANCE ( $\mu$ ).
- SPECIAL FUNCTIONS "Fx".

**WARNING:** Remember that this process of welding is synergic and for this reason the alteration of an individual parameter synergically also influences other parameters according to the pre-defined settings that are not modifiable!

## 7 - HOLD

This function automatically starts itself at the conclusion of every welding operation and it is indicated to the operator by means of a flashing light of the HOLD FUNCTION LED for a specific amount of time.

Once the welding has been terminated, for about **15** seconds, both the DISPLAYS should show the same values of the parameters during the welding.

In this phase the displays show:

- PARAMETER DISPLAY screen - A (D1)

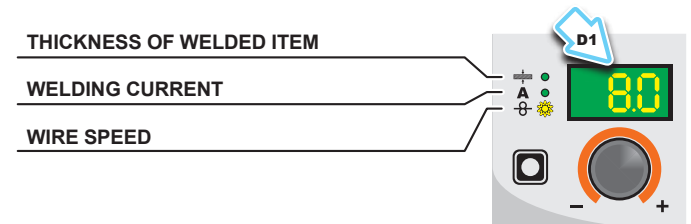

- THICKNESS OF WELDED ITEM ( $\equiv$ ): the value previously set.
- WELDING CURRENT (**A**): the last current value measured.
- WIRE SPEED ( $\omin�$ ): the value previously set.
- PARAMETER DISPLAY screen - V (D2)

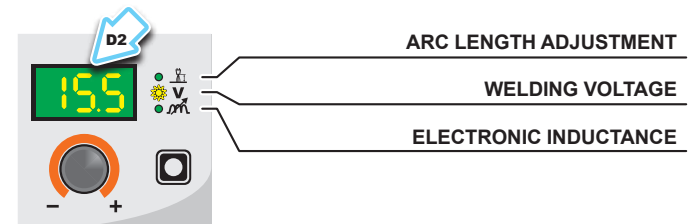

- ARC LENGTH ADJUSTMENT ( $\downarrow$ ): the value previously set.
- WELDING VOLTAGE (**V**): the last voltage value measured.
- ELECTRONIC INDUCTANCE ( $\mu$ ): the value previously set.

To interrupt the HOLD function and go back to the PRESETTING phase before **15** seconds have passed, simply turn one of the two ENCODER knobs (E1-E2).

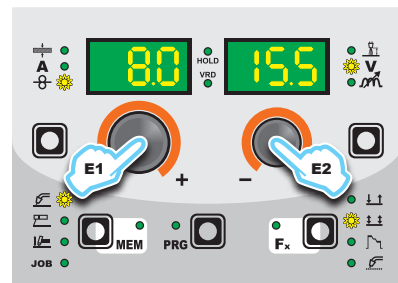

The HOLD function can be terminated ahead of time even while once again starting the welding.

Once **15** seconds have passed (HOLD FUNCTION) the control panel goes back to the PRESETTING phase.

# MIG-MAG manual

Start the welder by pressing the switch, located on the back panel, at the position I.

## 1 - WELDING PROCESS SELECTION

Select the MIG-MAG manual PROCESS of welding, pressing and releasing, even various times if necessary, the WELDING PROCESS SELECTION key (T2) until the corresponding LED lights up.

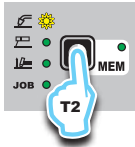

Push the SELECT PROGRAM key (T5). The corresponding LED switches on.



To access the MIG-MAG synergic welding process: rotate the ENCODER knob - A (E1) until obtaining on the PARAMETER DISPLAY screen - A (D1) and the writing **MAN**.

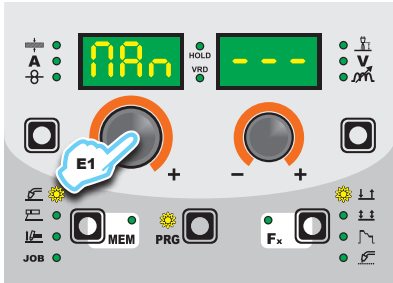

## 2 - WELDING MODE SELECTION

Select the MODE of welding, pressing and releasing, even various times if necessary, the WELDING MODE SELECTION key (T3) until the corresponding LED lights up.

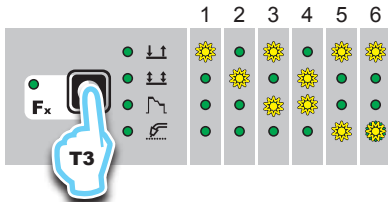

1. TWO STROKE (2T)
2. FOUR STROKE (4T)
3. CRATER 2T
4. CRATER 4T
5. SPOT WELDING 2T
6. STITCH WELDING 2T

## 3 - SPECIAL FUNCTIONS "Fx" SELECTION

The SPECIAL FUNCTIONS "Fx" that are only available in the MIG-MAG manual welding process are shown below. For all the other explanations regarding this menu make reference to the relative paragraph.

- **PRE GAS (PrG)** - Provides an additional quantity of gas for a defined time, before welding starts.
- **STARTING SPEED (StS)** - Regulates the speed at which the wire approaches the workpiece. The value indicated is a percentage variation in relation to the factory setting value.
- **HOT START (HoT)** - Regulates the current intensity for igniting the welding arc. The value indicated is a percentage variation in relation to the factory setting value.
- **CRATER START SPEED (F08)** - Sets the initial speed of the welding wire for the crater.
- **CRATER START VOLTAGE (F09)** - Sets the initial welding voltage for the crater.

- **CRATER START TIME (F10)** - This function defines the time in which the current remains at the value of CRATER START SPEED or CRATER START VOLTAGE.
- **CRATER START SLOPE (F11)** - Time taken to go from the CRATER START SPEED or CRATER START VOLTAGE level to the welding speed or voltage level.
- **CRATER END SLOPE (F12)** - Time required to go from the welding speed or voltage level to the CRATER END SPEED or CRATER END VOLTAGE level.
- **CRATER END SPEED (F13)** - Sets the final speed of the welding wire for the crater.
- **CRATER END VOLTAGE (F14)** - Sets the final welding voltage for the crater
- **CRATER END TIME (F15)** - This function defines the time in which the current remains at the value of CRATER END SPEED or CRATER END VOLTAGE.
- **SPOT WELD TIME (F07)** - The time during which spot welding takes place after the arc is ignited, after which the arc is extinguished automatically.
- **STITCH WELD TIME (F05)** - Time in which the welding in tracts is performed after the ignition of the arch, after which the arch switches off automatically.
- **STITCH WELD PAUSE (F06)** - Time of pause between one welding in tracts and another.
- **BURN BACK (bUb)** - Regulates the length of the wire after welding. The value indicated is a percentage variation in relation to the factory setting value. Higher numbers correspond to more burning of the wire.
- **POST GAS (PoG)** - Provides an additional quantity of gas for a defined time, after welding ends.
- **CYCLE WIRE SPEED (F19)** - Sets the speed for cycle welding (only available if CYCLE is enabled in the SETUP).
- **CYCLE VOLTAGE (F20)** - Sets the voltage for cycle welding (only available if CYCLE is enabled in the SETUP).

### PROGRAM DEFAULT (dEF)

**WARNING:** If carried out, this operation resets the program in use to the factory default settings.

To carry out the reset of the settings / parameters, proceed in the following manner:

- Rotate the ENCODER - A (E1) knob until both the displays read **dEF no** (see figure).

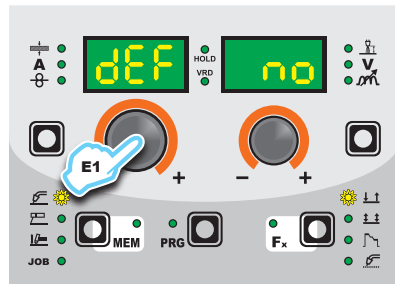

- Rotate the ENCODER - V knob (E2) until the PARAMETERS DISPLAY - V screen (D2) reads **YES**.

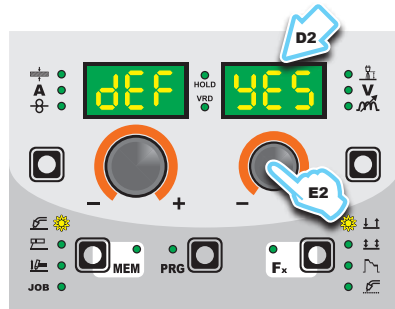

- Hold the SAVE "MEM" key (T2) down for at least 2 consecutive seconds.

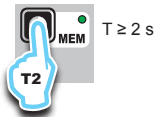

- The program in use has now been completed successfully. To confirmation the above, the control panel of the welder performs a short operation of MACHINE CHECK (all of the LED stay lit simultaneously so as to verify their actual operation), the generator itself starts, having memorised the new settings and is again ready to weld.

#### 4 - PRE-SETTING

Before welding it is possible to set the following parameters:



Example: WIRE SPEED

Press the PARAMETER SELECTION - A key (T1) until the LED that corresponds to the WIRE SPEED switches on. Turn the ENCODER - A knob (E1) to change the value shown on the PARAMETER DISPLAY - A screen (D1).

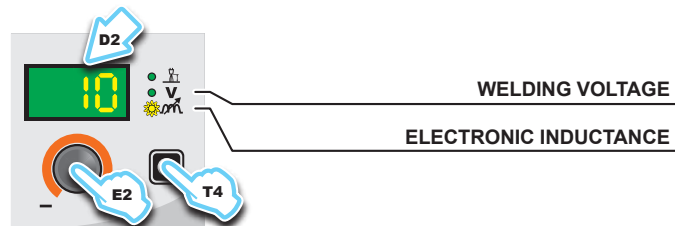

Example: ELECTRONIC INDUCTANCE

Press the PARAMETER SELECTION - V key (T4) until the LED that corresponds to the ELECTRONIC INDUCTANCE switches on. Turn the ENCODER - V knob (E2) to change the value shown on the PARAMETER DISPLAY - V screen (D2).

#### 5 - WELDING

During the welding the display shows:

- PARAMETER DISPLAY screen - A (D1)

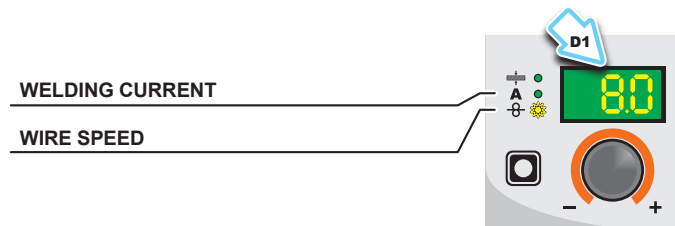

- WELDING CURRENT (**A**): the measured value of the current of what is being welded.
- WIRE SPEED (**-Ø-**): the value previously set.

- PARAMETER DISPLAY screen - V (D2)

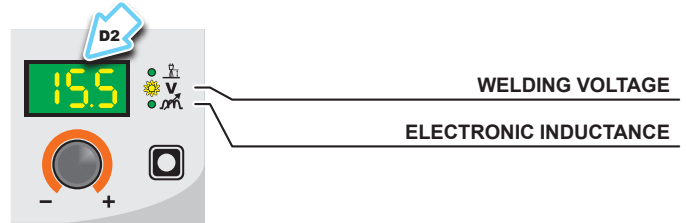

- WELDING VOLTAGE (**V**): the measured value of the voltage of what is being welded.
  - ELECTRONIC INDUCTANCE (**mH**): the value previously set.
- During the welding the operator can change the following parameters:

- WIRE SPEED (**-Ø-**).
- WELDING VOLTAGE (**-V-**).
- ELECTRONIC INDUCTANCE (**mH**).
- SPECIAL FUNCTIONS "Fx".

#### 6 - HOLD

This function automatically starts itself at the conclusion of every welding operation and it is indicated to the operator by means of a flashing light of the HOLD FUNCTION LED for a specific amount of time.

Once the welding has been terminated, for about 15 seconds, both the DISPLAYS should show the same values of the parameters during the welding.

In this phase the displays show:

- PARAMETER DISPLAY screen - A (D1)

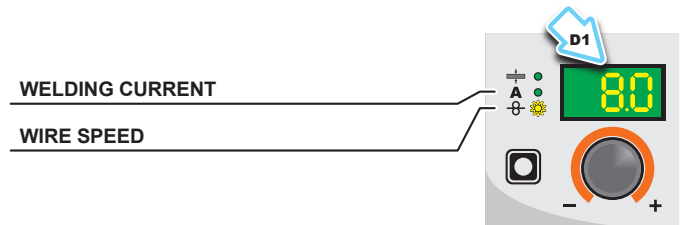

- WELDING CURRENT (**A**): the last current value measured.
- WIRE SPEED (**-Ø-**): the value previously set.

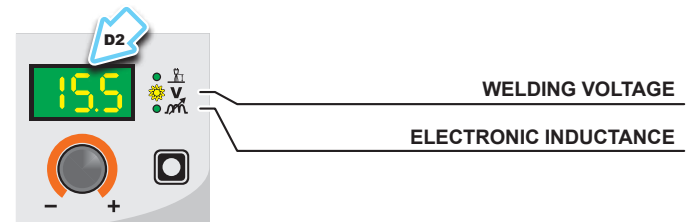

- WELDING VOLTAGE (**V**): the last voltage value measured.
- ELECTRONIC INDUCTANCE (**mH**): the value previously set.

To interrupt the HOLD function and go back to the PRESETTING phase before 15 seconds have passed, simply turn one of the two ENCODER knobs (E1-E2).

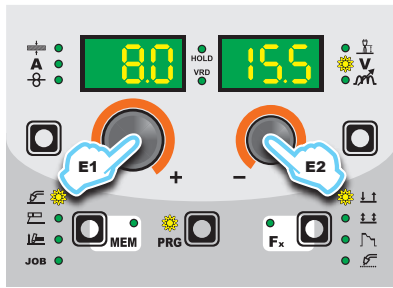

The HOLD function can be terminated ahead of time even while once again starting the welding. Once 15 seconds have passed (HOLD FUNCTION) the control panel goes back to the PRESETTING phase.

## Special processes

The welding machine can be equipped with additional welding programs, by having some software packages activated, against payment and by request. CEA has designed and developed the following SPECIAL PROCESSES.

### vision.COLD (CLd)

This is an innovative MIG/MAG process with low heat transfer, developed by CEA for welding thin plating and MIG brazing in all welding positions. The synergic vision-COLD programs make optimum quality welding possible, with minimum deformation and changes in metallurgical characteristics.

For this reason, the **vision.COLD** software is also an excellent solution for welding open joints.

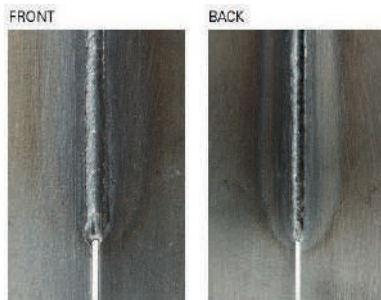

### vision.ULTRASPEED (SPd)

Power MIG 255 Pulse

This is an innovative MIG/MAG process developed by CEA for welding steel and non ferrous materials that, due to the increased magnetic resistance of the arc and the tighter cone, allows a significant increase in welding speed. This process causes lower heating up at the base material, minimising deformation and making it possible to reduce work and finishing times for the welded item. **vision.ULTRASPEED** makes it possible to speed up welding compared with short arc and mixed arc MIG/MAG welding, greatly increasing productivity.



### EXTENDED CURVES PACKAGE (ECP)

This is a package of additional curves, dedicated to highly specialised machining and procedures.

To set the welding machine and make use of the special processes purchased, the operator must refer to the relevant functions and programs table sold with the software.

## Electrode (MMA)

Start the welder by pressing the switch, located on the back panel, at the position I.

### 1 - WELDING PROCESS SELECTION

Select the ELECTRODE PROCESS of welding (for welding with "HOT START" and "ARC FORCE" devices, programmable by the user) pressing and releasing, even various times if necessary, the WELDING PROCESS SELECTION key (T2) until the corresponding LED lights up.

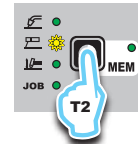

Push the SELECT PROGRAM key (T5). The corresponding LED switches on.



### 2 - SELECTION OF WELDING PROGRAM

PROGRAM TABLE <input type="checkbox"/> PRG			
MMA PROCESS			
MATERIAL		DISPLAY	
TYPE	CLASS		
Basic	E7018	MMA	bAS
Rutil	E6013	MMA	rUt
Cr-Ni	E316L	MMA	Crn

Select the welding PROGRAM by pushing the SELECT PROGRAM key (T5), and then rotate the ENCODER - V (E2) Knob until the VIEW PARAMETERS - V (D2) display shows the program required, chosen according to the type of electrode to be used (basic, rutile, and chrome-nickel).

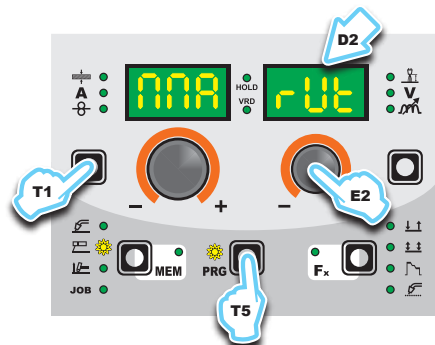

### 3 - SPECIAL FUNCTIONS “Fx” SELECTION

ADJUSTABLE FUNCTIONS “Fx” <input type="checkbox"/> Fx > 3s			
FUNCTION	DISPLAY	SETTINGS RANGE	
		FACTORY	RANGE
HOT START	Hot	50	0 ÷ 100
ARC FORCE	ArC	50	0 ÷ 100
PROGRAM DEFAULT	dEF	no	no - YES

The SPECIAL FUNCTIONS “Fx” that are only available in the MMA welding process are shown below. For all the other explanations regarding this menu make reference to the relative paragraph.

- **HOT START (Hot)** - At the start of the welding process it increases the current, adjustable in percentage, reducing in such a way the risk of low function at the start of the connection.
- **ARC FORCE (ArC)** - During the welding process, it increases the current in percentage, reducing in such a way the risk of fusing the electrode to the piece.

#### PROGRAM DEFAULT (dEF)

**WARNING:** If carried out, this operation resets the program in use to the factory default settings.

To carry out the reset of the settings / parameters, proceed in the following manner:

- Rotate the ENCODER - A (E1) knob until both the displays read **dEF no** (see figure).

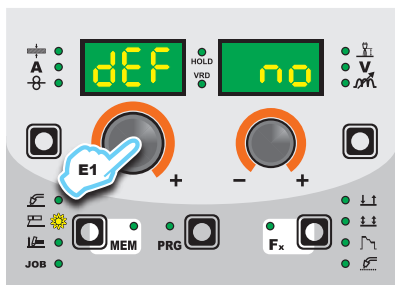

- Rotate the ENCODER - V knob (E2) until the PARAMETERS DISPLAY - V screen (D2) reads **YES**.

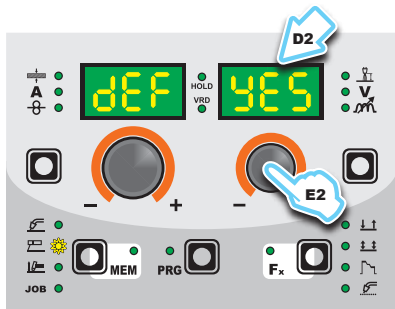

- Hold the SAVE “MEM” key (T2) down for at least 2 consecutive seconds.

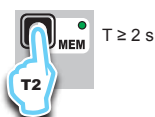

- The program in use has now been completed successfully. To confirmation the above, the control panel of the welder performs a short operation of MACHINE CHECK (all of the LED stay lit simultaneously so as to verify their actual operation), the generator itself starts, having memorised the new settings and is again ready to weld.

### 4 - PRE-SETTING

Before welding it is possible to set the following parameters:



#### Example: WELDING CURRENT

Press the PARAMETER SELECTION - A key (T1) until the LED that corresponds to the WELDING CURRENT switches on. Turn the ENCODER - A knob (E1) to change the value shown on the PARAMETER DISPLAY - A screen (D1).

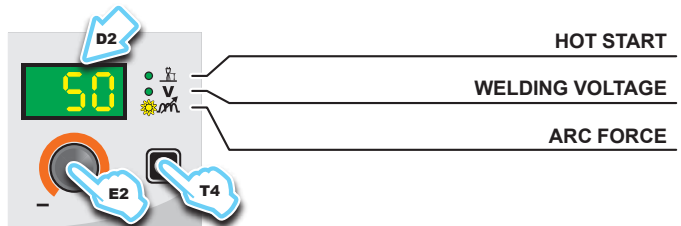

#### Example: ARC FORCE

Press the PARAMETER SELECTION - V key (T4) until the LED that corresponds to the ARC FORCE switches on. Turn the ENCODER - V knob (E2) to change the value shown on the PARAMETER DISPLAY - V screen (D2).

### 5 - WELDING

During the welding the display shows:

- PARAMETER DISPLAY screen - A (D1)

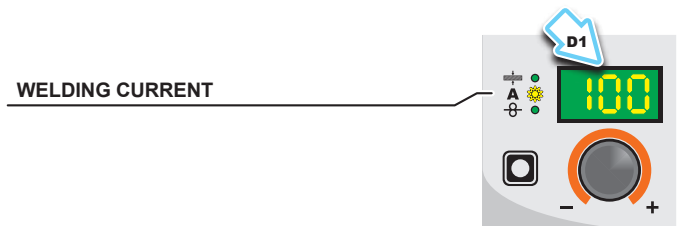

- WELDING CURRENT (**A**): the measured value of the current of what is being welded.
- PARAMETER DISPLAY screen - V (D2)

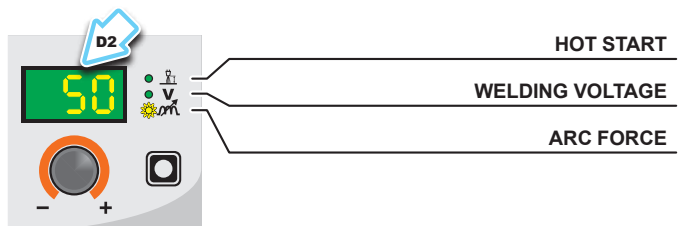

- HOT START (**H**): the value previously set.
- WELDING VOLTAGE (**V**): the measured value of the voltage of what is being welded.
- ARC FORCE (**m**): the value previously set.

During the welding the operator can change the following parameters:

- WELDING CURRENT (**A**).
- HOT START (**H**).
- ARC FORCE (**m**).
- SPECIAL FUNCTIONS “Fx” - FIRST LEVEL MENU.



## 6 - HOLD

This function automatically starts itself at the conclusion of every welding operation and it is indicated to the operator by means of a flashing light of the HOLD FUNCTION LED for a specific amount of time. Once the welding has been terminated, for about **15** seconds, both the DISPLAYS should show the same values of the parameters during the welding. In this phase the displays show:

- PARAMETER DISPLAY screen - A (D1)



- WELDING CURRENT (**A**): the last current value measured.
- PARAMETER DISPLAY screen - V (D2)

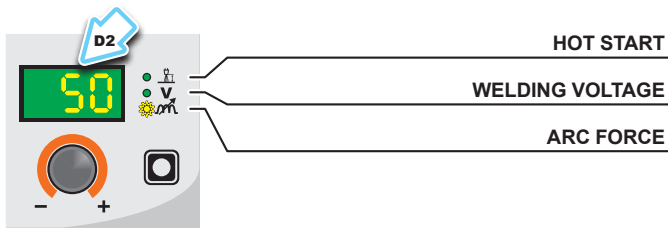

- HOT START ( $\frac{1}{2}$ ): the value previously set.
  - WELDING VOLTAGE (**V**): the measured value of the last voltage of what is being previously welded.
  - ARC FORCE ( $\mu m$ ): the value previously set.
- To interrupt the HOLD function and go back to the PRESETTING phase before **15** seconds have passed, simply turn one of the two ENCODER (E1-E2) knobs.

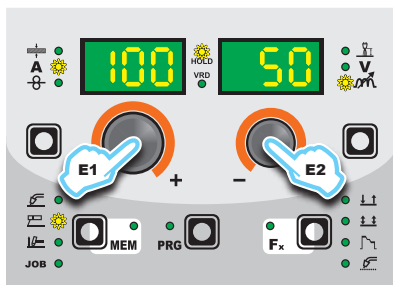

The HOLD function can be terminated ahead of time even once again starting the welding. Once **15** seconds have passed (HOLD FUNCTION) the control panel goes back to the PRESETTING phase.

## 7 - ACTIVATING THE VRD DEVICE

The Voltage Reduction Device (VRD) is a safety device that reduces voltage. It prevents voltages forming on the output terminals that may pose a danger to people. The factory settings do NOT set out an active welding device during electrode welding.

If the operator wishes to weld in MMA using the VRD device (which must be done with the welding machine switched off), they must:

- 1) Use a suitable screwdriver to unscrew the 4 screws that fix the control panel to the welding machine.
- 2) Remove the "VRD" JUMPER on the DIGITAL INTERFACE PCB (Fig. B).
- 3) Use a suitable screwdriver to tighten the 4 screws that fix the control panel to the welding machine.
- 4) Start the welder by pressing the switch, located on the back panel, at the position I.

After switching on, but with the machine at rest, the control panel will show the VRD LED on in the colour GREEN and this means that the device is active.

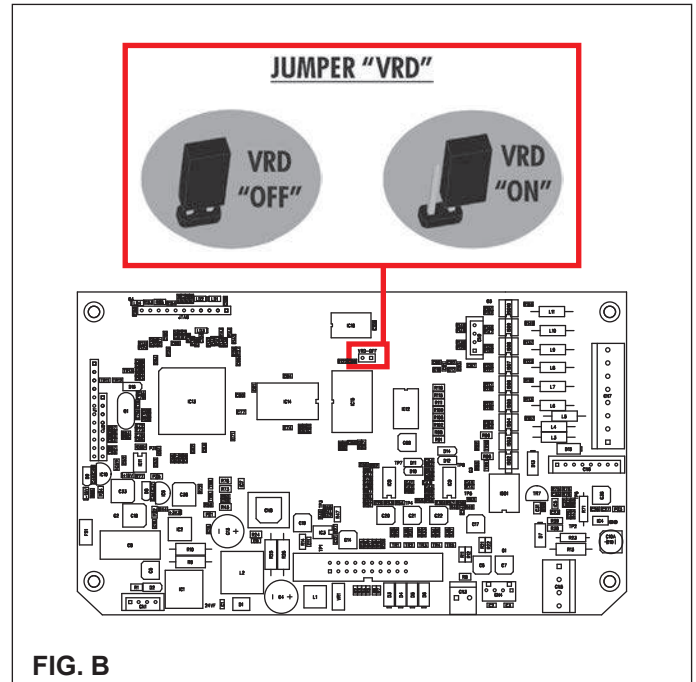

FIG. B

During the welding phase, this LED becomes RED, which however does not indicate a malfunctioning of the welder but the fact that the VRD device is in function and, at the conclusion of the welding operation, the tension will be reduced within a maximum greatest time of **0.3 seconds**.

## TIG with "Lift" striking

Start the welder by pressing the switch, located on the back panel, at the position I.

### 1 - WELDING PROCESS SELECTION

Select the TIG PROCESS of welding with "Lift" type starter for welding without high frequency, pressing and releasing, also more times if necessary, the WELDING PROCESS SELECTION key (T2) until the corresponding LED lights.

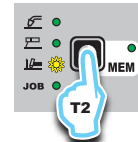

### 2 - SPECIAL FUNCTIONS "Fx" SELECTION

ADJUSTABLE FUNCTIONS "Fx" <input type="checkbox"/> Fx > 3s			
FUNCTION	DISPLAY	SETTINGS RANGE	
		FACTORY	RANGE
<b>TIG process</b>			
UP SLOPE	F29	0.0s	(0.0 ÷ 20.0)s
DOWN SLOPE	F30	2.0s	(0.0 ÷ 20.0)s
SWS VOLTAGE LIMIT	F31	0	-30 ÷ 30
PROGRAM DEFAULT	dEF	no	no - YES

The SPECIAL FUNCTIONS "Fx" that are only available in the TIG Lift welding process are shown below. For all the other explanations regarding this menu make reference to the relative paragraph.

- **UP SLOPE (F29)** - Allows the joining of the WELDING CURRENT to the INITIAL CURRENT.
- **DOWN SLOPE (F30)** - Allows the joining of the WELDING CURRENT to the FINAL CURRENT.
- **SWS VOLTAGE LIMIT (F31)** - Regulates the voltage level for automatic automatic extinguishing.

## PROGRAM DEFAULT (DEF)

**WARNING:** If carried out, this operation resets the program in use to the factory default settings.

To carry out the reset of the settings / parameters, proceed in the following manner:

- Rotate the ENCODER - A (E1) knob until both the displays read **DEF no** (see figure).

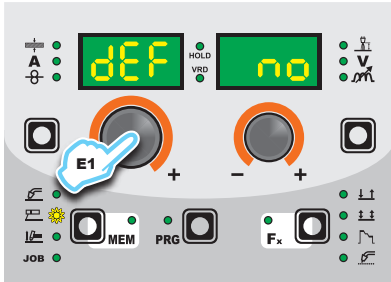

- Rotate the ENCODER - V knob (E2) until the PARAMETERS DISPLAY - V screen (D2) reads **YES**.

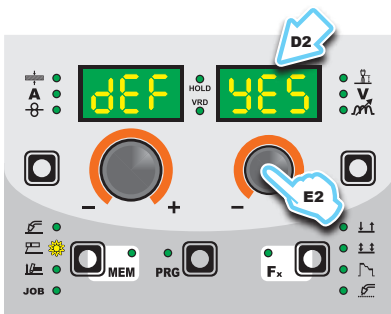

- Hold the SAVE "MEM" key (T2) down for at least 2 consecutive seconds.

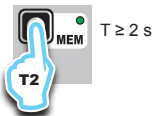

- The program in use has now been completed successfully. To confirmation the above, the control panel of the welder performs a short operation of MACHINE CHECK (all of the LED stay lit simultaneously so as to verify their actual operation), the generator itself starts, having memorised the new settings and is again ready to weld.

## 3 - PRE-SETTING

Before welding it is possible to set the following parameters:

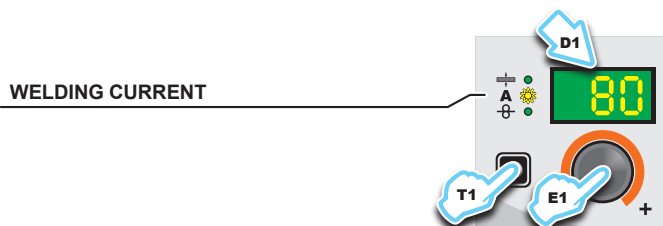

Example: WELDING CURRENT

Press the PARAMETER SELECTION - A key (T1) until the LED that corresponds to the WELDING CURRENT switches on. Turn the ENCODER - A knob (E1) to change the value shown on the PARAMETER DISPLAY - A screen (D1).

## 4 - WELDING

During the welding the display shows:

- PARAMETER DISPLAY screen - A (D1)



WELDING CURRENT

- WELDING CURRENT (**A**): the measured value of the current of what is being welded.

- PARAMETER DISPLAY screen - V (D2)



WELDING VOLTAGE

- WELDING VOLTAGE (**V**): the measured value of the voltage of what is being welded.

## 5 - HOLD

This function automatically starts itself at the conclusion of every welding operation welding and it is indicated to the operator by means of a flashing light of the HOLD FUNCTION LED for a specific amount of time. Once the welding has been terminated, for about 15 seconds, both the DISPLAYS should show the same values of the parameters during the welding.

In this phase the displays show:

- PARAMETER DISPLAY screen - A (D1)

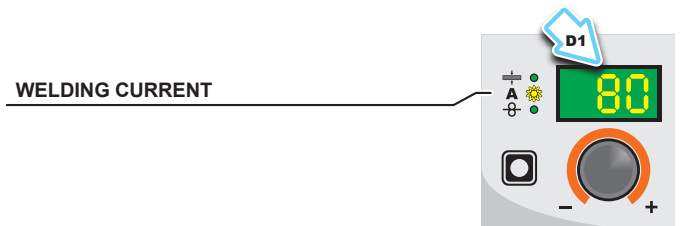

WELDING CURRENT

- WELDING CURRENT (**A**): the last current value measured.
- PARAMETER DISPLAY screen - V (D2)

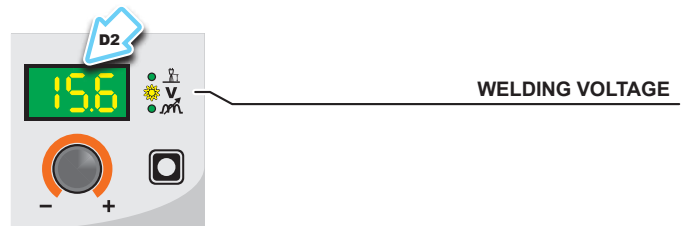

WELDING VOLTAGE

- WELDING VOLTAGE (**V**): the measured value of the last voltage of what is being previously welded.

To interrupt the HOLD function and go back to the PRESETTING phase before 15 seconds have passed, simply turn one of the two ENCODER (E1-E2) knobs.

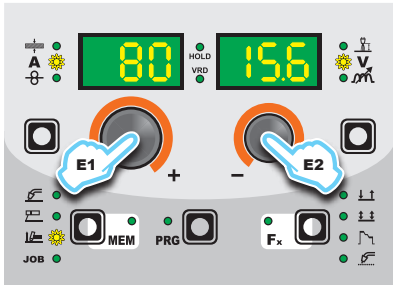

The HOLD function can be terminated ahead of time even once again starting the welding. Once 15 seconds have passed (HOLD FUNCTION) the control panel goes back to the PRESETTING phase.

## JOB

### 1 - CREATING AND SAVING A JOB

This operation makes it possible to create and save welding settings (points) that can be called up by the operator at any time. The control panel provides the possibility of saving a total of 99 JOBS spread over all the welding processes. There are not limits to the quantity or position of the points that can be saved for each process!

When it leaves the factory the welding machine does not have any JOBS saved in it and so the operator will find the control panel in this condition:



Having defined the parameters the operator needs to do their work correctly, they can be saved by creating an AUTOMATIC WELDING POINT (JOB), proceeding as follows:

- 1) Hold the SAVE "MEM" key (T2) down for at least 2 consecutive seconds until both displays show the flashing wording that represent the first AUTOMATIC WELDING POINT (JOB) free and/or available to the operator that can be used for saving the data (e.g.: A01).

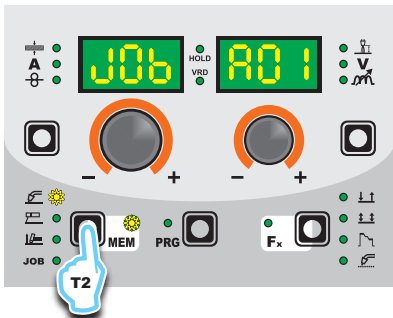

To be able to choose another automatic welding point (JOB) that is free for saving the data, simply turn one of the two ENCODER (E1-E2) knobs until you reach the required point.



**WARNING:** If all the automatic welding points (JOBS) are occupied, the check automatically goes to the first automatic welding point (JOB A01) as shown in the figure below).

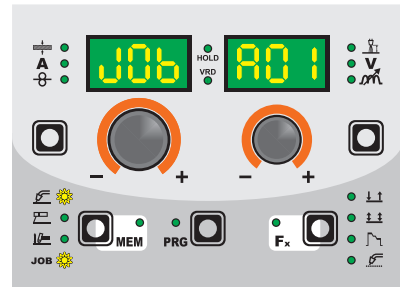

- 2) Hold down the SAVE "MEM" (T2) Key down for at least 2 consecutive seconds to save JOB and automatically load the settings / parameters (including special functions) for the JOB just saved.
- 3) To exit the JOB, press and release the WELDING PROCESS SELECTION key (T2).



### 2 - JOB SELECTION

Select the JOB, pressing and releasing, even various times if necessary, the WELDING PROCESS SELECTION key (T2) until the corresponding LED lights up.

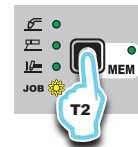

### 3 - PRE-SETTING / VIEWING MEMORISED JOB DATA

Since the parameters are memorised, within each JOB, viewable but not modifiable, the pre-setting phase does not exist, but the operator can see and verify the settings, previously saved and memorised, pressing and releasing the PARAMETER SELECTION key - A (T1) or in alternative the PARAMETER SELECTION key - V (T4).

The SPECIAL FUNCTIONS "Fx" Key (T3) contained within each individual JOB can be viewed (but not modified) by simply keeping the SPECIAL FUNCTIONS "Fx" key (T3) pressed for a duration of about 2 seconds.

The display of the parameters (special functions included) lasts only a few seconds, then the panel shows, in an automatic way, the previous working condition.

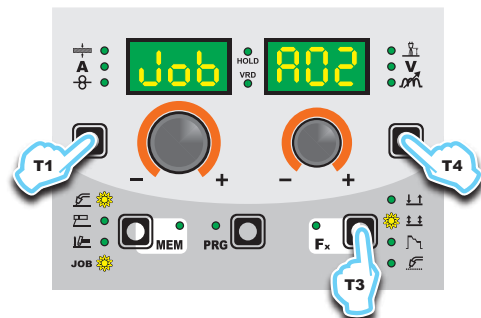

#### 4 - WELDING

During the welding the display shows the values, if possible measured, of the active parameters, based on the type of welding process, memorised within the selected JOB.

As already indicated, the parameters can be viewed by pressing and releasing the PARAMETER SELECTION key - A (T1) or in alternative the PARAMETER SELECTION key - V (T4), while the SPECIAL FUNCTIONS "Fx" key (T3) contained within each individual JOB can be viewed (but not modified) by simply keeping the SPECIAL FUNCTIONS "Fx" key (T3) pressed for a duration of about 3 seconds.

#### 5 - HOLD

This function automatically starts itself at the conclusion of every welding operation and it is indicated to the operator by means of a flashing light of the HOLD FUNCTION LED for a specific amount of time.

Once the welding has been terminated, for about 15 seconds, both the DISPLAYS should show the same values of the parameters during the welding.

To interrupt the HOLD function and go back to the PRESETTING phase before 15 seconds have passed, simply turn one of the two ENCODER (E1-E2) knobs.

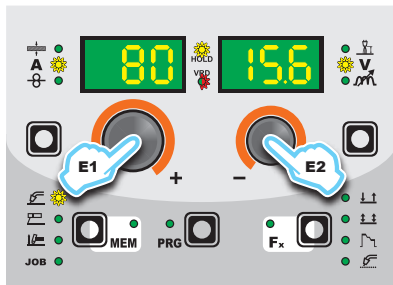

The HOLD function can be terminated ahead of time even once again starting the welding.

Once 15 seconds have passed (HOLD FUNCTION) the control panel goes back to the PRESETTING phase.

#### 6 - MODIFICATION AND OVERWRITING OF A MEMORISED JOB

To edit and overwrite a JOB proceed as follows:

- 1) Select JOB, pressing and releasing, even various times if necessary, the WELDING PROCESS SELECTION key (T2) until the corresponding LED lights up.
- 2) Select the individual JOB to modify and overwrite rotating the ENCODER knob - V (E2).
- 3) Bring up and activate the JOB, loading its settings in the welding process it comes from, keeping the SAVE "MEM" key (T2) pressed for a duration of about 2 seconds.
- 4) Acquire the parameters necessary for editing the JOB.
- 5) Hold the SAVE "MEM" key (T2) down for at least 2 consecutive seconds until both displays show the flashing wording that represent the first AUTOMATIC WELDING POINT (JOB) free and/or available to the operator that can be used for saving the data.
- 6) Rotate the ENCODER knob - V (E2) until identifying the individual JOB that will be overwritten.
- 7) Keep pressed, for at least 3 consecutive seconds, the SAVE "MEM" key (T2) to confirm and make the operation effective.

#### 7 - DELETING A JOB SAVED

In JOB mode, holding down the PARAMETER SELECTION - A (T1) and PARAMETER SELECTION - V (T4) keys down simultaneously for about 5 seconds deletes the current automatic welding point.

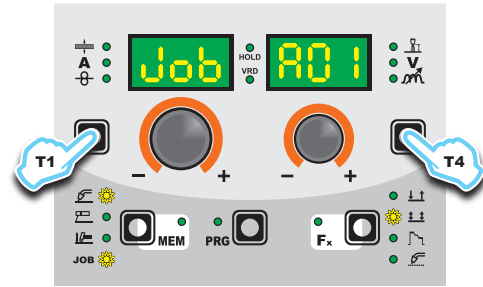

The control panel automatically goes to the first JOB saved or reads "no JOB" if no JOBS have been saved.



## Error condition

This paragraph describes the error conditions that may arise on the welding machine, the codes and messages shown on both operator interface displays, and the diagnoses for attempting to correct and resolve them.

In an "error condition" the operator's interface uses both displays to display:

- ERROR CONDITION display
- ERROR DESCRIPTION display

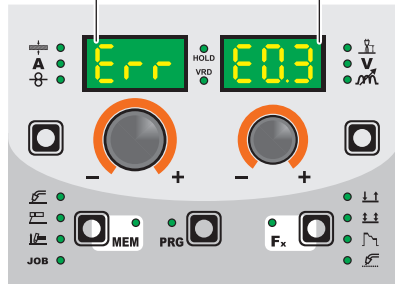

Error condition	Error code	Error description and possible diagnosis
AUT	ADJ	POWER LIMITATION This alarm appears if the power limit is exceeded. The alarm alternates with the standard display every 1.5 seconds, despite which the machine continues to weld, supplying limited power, but complying with the values shown on the data plate.
Err	T°C	THERMAL PROTECTION The welding stops due to an excessively high temperature (thermostat activated). Automatic reset error.
Err	H20	COOLER PRESSURE The fluid in the cooling system is at low pressure. <b>NON automatic reset error.</b>
Err	E0.0	POWER SUPPLY FAILURE <b>NON automatic reset error.</b> This error can only arise when switching on and not when the welding equipment is working normally.
Err	E0.1	OVER AND UNDER VOLTAGE Automatic reset error.
Err	E0.2	OVER VOLTAGE Automatic reset error.
Err	E0.3	UNDER VOLTAGE Automatic reset error.
Err	E0.4	OVER CURRENT Automatic reset error.
Err	E1.0	CONFIG. FILE MISSING <b>NON automatic reset error. Immediately contact technical assistance dept.</b>
Err	E1.1	USER FILE MISSING <b>NON automatic reset error. Immediately contact technical assistance dept.</b>
Err	E1.3	CALIBRATION FILE MISSING <b>NON automatic reset error. Immediately contact technical assistance dept.</b>
Err	E1.6	MMA DEFAULTS MISSING <b>NON automatic reset error. Immediately contact technical assistance dept.</b>
Err	E1.7	DEFAULTS MISSING TIG <b>NON automatic reset error. Immediately contact technical assistance dept.</b>
Err	E1.8	DEFAULTS MISSING MIG <b>NON automatic reset error. Immediately contact technical assistance dept.</b>
Err	E1.9	WELDER DEFAULTS MISSING <b>NON automatic reset error. Immediately contact technical assistance dept.</b>
Err	E2.0	FILE SYSTEM ERROR <b>NON automatic reset error. Immediately contact technical assistance dept.</b>

(continued)

Error condition	Error code	Error description and possible diagnosis
Err	E3.2	STICKING This error is displayed when a shortcircuit has been formed between the machine's output terminals for more than 1.2 seconds. <b>NON automatic reset error.</b> To remove the error state, eliminate the short circuit so that the voltage on the torch goes above the threshold value again. At this stage the error condition disappears and the welding machine goes back to the mode prior to the sticking. If the torch trigger is still pushed, it must be released and pressed again to begin welding again.
Err	E4.0	LAST SETUP NOT VALID <b>NON automatic reset error. Immediately contact technical assistance dept.</b>
Err	E4.1	JOBS WRONG <b>NON automatic reset error. Immediately contact technical assistance dept.</b>
Err	E4.2	MIG SYN SPECIAL FUNCTION "Fx" WRONG <b>NON automatic reset error. Immediately contact technical assistance dept.</b>
Err	E4.3	MIG MAN SPECIAL FUNCTION "Fx" WRONG <b>NON automatic reset error. Immediately contact technical assistance dept.</b>
Err	E4.4	SPECIAL "Fx" PULSED MIG FUNCTIONS NOT VALID <b>NON automatic reset error. Immediately contact technical assistance dept.</b>
Err	E5.0	MIG PROGRAMS MISSING <b>NON automatic reset error. Immediately contact technical assistance dept.</b>
Err	E5.1	NO PULSED MIG WELDING PROGRAMS <b>NON automatic reset error. Immediately contact technical assistance dept.</b>
Err	E5.3	PROGRAMS MISSING <b>NON automatic reset error. Immediately contact technical assistance dept.</b>
Err	E5.4	NO WELDING PROGRAMS <b>NON automatic reset error. Immediately contact technical assistance dept.</b>

The table includes 2 types of errors:

- **Automatic reset error:** Once the alarm condition has been resolved the welding machine starts working again and the operator can weld again!
- **NON automatic reset error:** To remove the alarm status and reinstate correct operation of the machine, the welding equipment must be switched off.

The machine will then be working again and the operator can weld again!

**PLEASE NOTE: If, when switching on, the error status presents itself again, immediately contact the Technical Assistance Department.**

This is necessary so that our technical assistance dept (**that must be contacted each time the error messages appear on the welding machine's operator interface**) is able to resolve the problems more easily and as quickly as possible, thanks to the reports by the user, and also because, in the meantime the welding machine does not allow the operator to do their work.

# Power MIG Series



**GeKaMac**<sup>®</sup>



**Gedik Welding Inc.**

Ankara Caddesi No: 306 Şeyhli 34906 Pendik - İstanbul / Turkey

**P.** +90 216 378 50 00 • **F.** +90 216 378 20 44

[www.gedikwelding.com](http://www.gedikwelding.com)